

bencore[®]

DESIGN SOLUTIONS

Product manual

April 2011



INDEX

1. PRODUCT DESCRIPTION	04
1.1 Starlight	04
1.2 Lightben	04
1.3 Hexaben	04
1.4 Ecoben	04
2. HANDLING AND STORAGE	05
3. MANTAINANCE	06
3.1 Starlight - Plus - Class and Lightben - Plus	06
3.2 Starlight, Starlight-Extra, Lightben.....	06
3.3 Starlight - Plus - UVP, Lightben - Plus -UVP, Starlight Plus Floor	07
3.4 Hexaben - Normal, Large, Plus	07
4. PRODUCTS PROCESSING	08
4.1 Cutting with circular saw	08
4.1.1 Cutting specifications	08
4.1.2 Cutting specifications recommended by raw material manufacturers	010
4.1.3 Troubleshooting	012
4.2 Drilling.....	013
4.3 Milling	014
4.4 Edging	015
4.5 Gluing and Assembling	018
4.6 Polishing	020
4.7 Thermoforming	020
4.8 Laser and Water-jet Cutting	022
4.9 Sealing edges	022
5. UTILIZATION GUIDELINES	023
5.1 Outdoor use (vertical partitions, roofs, skylights)	023
5.2 Raised floors	023
5.3 Indoor highly-humid environments and/or in vapour presence	023
5.4 Backlit	023
5.5 Fire Certifications	025
5.6 Making furniture components	026
5.6.1 Shelves: dimensions and loads	026
5.6.2 Complex structures	026
6. TROUBLESHOOTING	028
6.1 Scratches-tears of the protective film	028
6.2 Partial detachment of external skin	028
6.3 Condensation inside core cells	028
7. SAFETY NOTES	029
8. ATTACHMENTS	030
Attachment 1: Products technical data sheets	030
Attachment 2: Tables of surface chemical resistance	036
Attachment 3: Adhesive compatibility	041
Attachment 4: Safety data sheets	042

1. PRODUCT DESCRIPTION

1.1. STARLIGHT

Composite panel made with a conic-cells transparent honeycomb core laminated with two layers of transparent/coloured/satin-finished resin.

Starlight is available in the following variations:

STARLIGHT BASIC

Standard entry-level product.

STARLIGHT EXTRA

In comparison with Starlight Basic, has a stronger core: it is suitable for structural uses and when machining is needed (like 45°cuts, milling etc.)

STARLIGHT PLUS

Panels with Fire Certification

STARLIGHT PLUS FLOOR

Panels specific for raised floors and structural applications with high loads

STARLIGHT PLUS UVP

UV-resistant panels thanks to the use of PC skins, which are coextruded and UV-protected.

1.2. LIGHTBEN

A composite panel with a clear Polycarbonate cylindrical-cells honeycomb core, laminated with layers of transparent/coloured/satin-finished plastic material.

Lightben is available in the following variations:

LIGHTBEN BASIC

Standard entry-level product.

LIGHTBEN PLUS

Panels with a Fire Certification

LIGHTBEN PLUS CC (Coloured-Core)

A Lightben Plus with coloured Core.

LIGHTBEN PLUS UV

UV resistant panels thanks to UV co-extruded Polycarbonate external layers.

1.3. HEXABEN

Composite panel with Aluminium honeycomb core with hexagonal cells, deriving from aeronautical use. External layers are in plastic material clear or coloured, with glossy / satin finishing.

HEXABEN panel is available in the following variations. **SMALL, SMALL PLUS, LARGE, LARGE PLUS.**

1.4. ECOBEN

Composite panel with recycled cardboard core and external layers in co-polyester resin (OPETG) or acrylic resin (PMMA), clear / coloured, in glossy / satin finishing.

ECOBEN is available as **ECOBEN WAVE** featuring a wave-shaped-cells core.

STARLIGHT

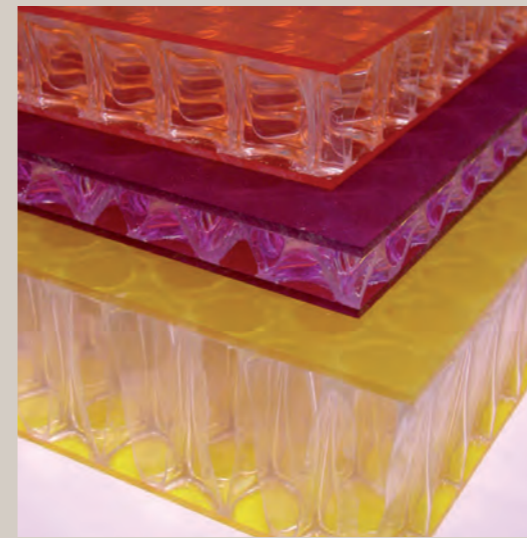

LIGHTBEN

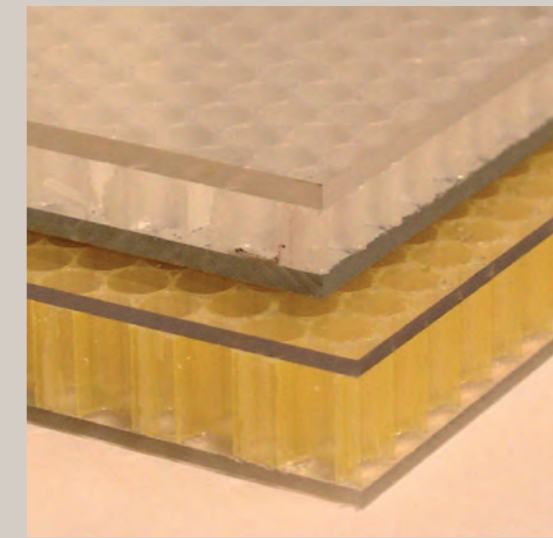

Please refer to the Technical Data Sheets for panel characteristics (attachment 1)

HEXABEN SMALL E LARGE

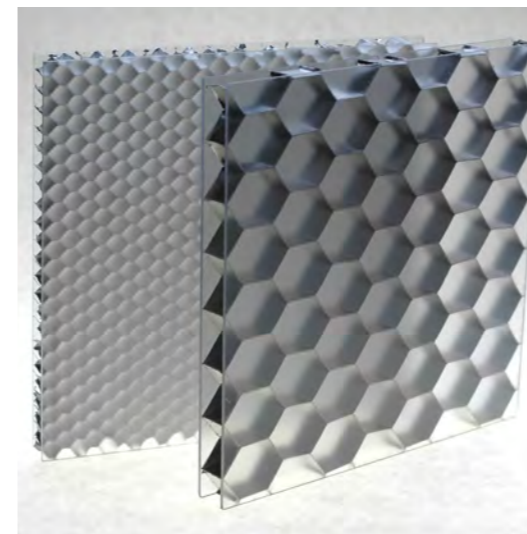

ECOBEN

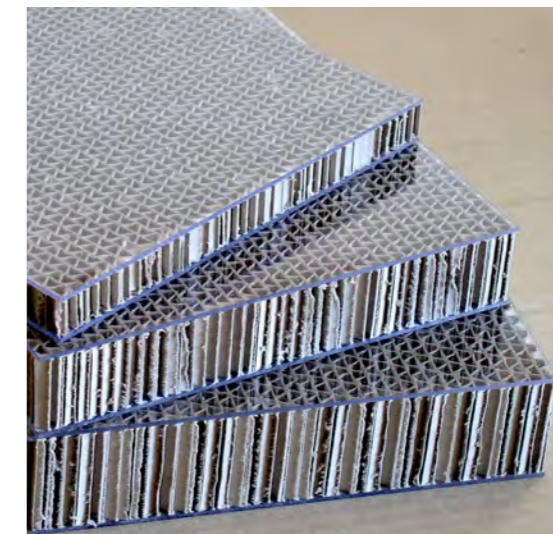

2. HANDLING AND STORAGE

A plastic film protects **STALIGHT**, **LIGHTBEN**, **HEXABEN** and **ECOBEN** panels.

It is advisable to keep the protective film in place for as long as possible, until panel installation. Storage must be carried out in a sheltered location (warehouse) with temperatures between 10°C and +30°C, avoiding direct sunlight, exposure to rain and snow, and presence of corrosive substances and/or solvents.

Handling of a single panel must be done in a vertical position avoiding rubbing between panels.

Horizontal storage is advised with the following recommendations:

- Keep the original Bencore packing intact and place it on an even and regular surface.
- In case of a new storage, place the panels on an even and regular surface, avoiding the presence of dirt particles between panels (it is advisable to protect surfaces placing a protective layer between the panels).

STORAGE OF BENCORE PANELS: HORIZONTAL POSITION

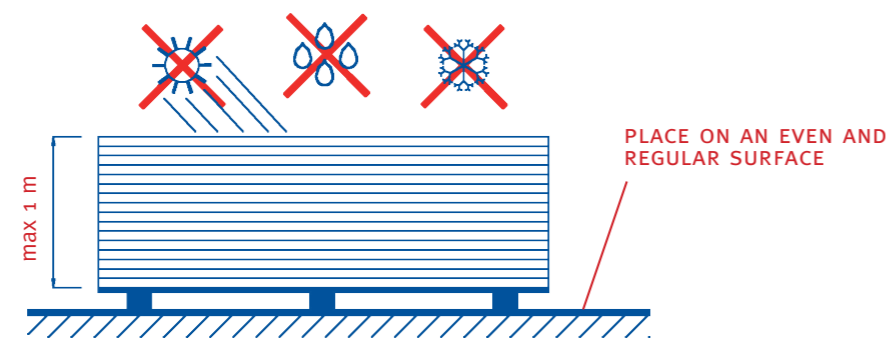

STORAGE OF BENCORE PANELS: VERTICAL POSITION

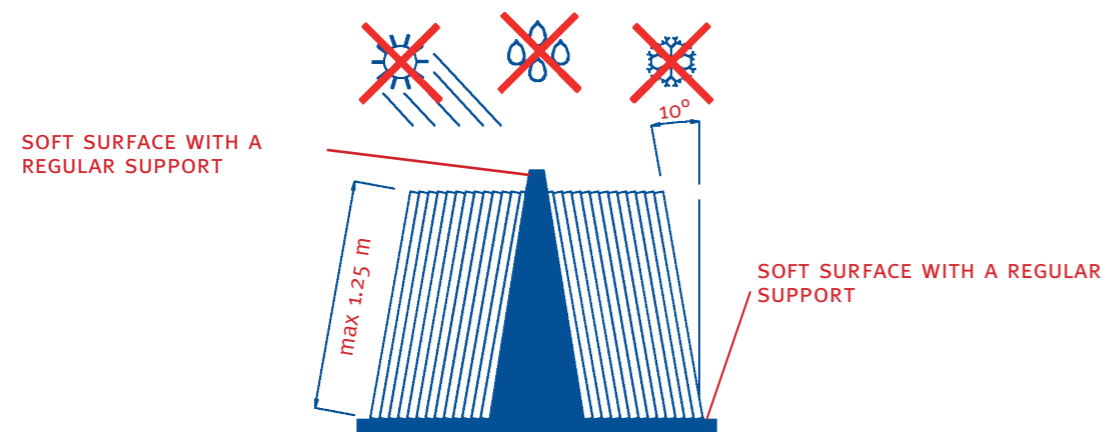

It is possible to store panels vertically placing them resting on their longer sides, tilted at an angle of 10 degrees from vertical; the support must be uniform and continuous and must be against soft surfaces (rubber, foam, etc...). Improper storage can damage and/or permanently deform panels.

3. MANTAINANCE

3.1. STARLIGHT - PLUS - LIGHTBEN - PLUS

Dust and mill scale removal

Edge cleaning: blow with compressed air on the edges.

Surfaces cleaning: blow with compressed air and/or use an antistatic cloth wiping gently in order to avoid abrasions.

Dirt and fingerprints removal from surfaces

Use a solution of lukewarm water (max 40°) with neutral detergent or isopropyl alcohol diluted with water to 50% strength, gently rub with a soft sponge and rinse with cold water. Dry with a soft cloth or a wet buff.

Do not:

- Use detergents others than those indicated above
- Use a dry cloth for dry dirt removal
- Clean panels under direct sunlight or high temperatures.
- Use abrasives, squeegees, blades, pointed tools, roto-brush systems

For tables of chemical resistance of surfaces, please refer to attachment 2.

3. MANTAINANCE

3.2. STARLIGHT, STARLIGHT-EXTRA, LIGHTBEN BASIC, HEXABEN SMALL/LARGE

Dust and mill scale removal from edges and surfaces

Edge cleaning: use compressed air to clean the edges.

Surface cleaning: blow with compressed air and/or use an antistatic cloth wiping gently in order to avoid abrasions.

Dirt and fingerprints removal from surfaces

Use a solution of lukewarm water (max 40°) with neutral detergent or isopropyl alcohol diluted with water to 50% strength, gently rub with a soft sponge and rinse with cold water. Dry with a soft cloth or a wet buff.

Do not:

- Use alcohol-based or highly alkaline detergents
- Use a dry cloth for dry dirt removal
- Clean panels under direct sunlight or high temperatures.
- Use abrasives, squeegees, blades, pointed tools, roto-brush systems

For tables of chemical resistance of surfaces, please refer to attachment 2.

3. MANTAINANCE

3.3. STARLIGHT - PLUS - UVP, LIGHTBEN - PLUS - UVP, STARLIGHT PLUS FLOOR PANELS - HEXABEN PLUS

Dust and mill scale removal from edges and surfaces

Edge cleaning: use compressed air to clean the edges.

Surface cleaning: blow with compressed air and/or use an antistatic cloth wiping gently in order to avoid abrasions.

Dirt and fingerprints removal from surfaces

Use a solution of lukewarm water (max 40°) with neutral detergent or with neutral detergent or isopropyl alcohol diluted with water to 50% strength, gently rub with a soft sponge and rinse with cold water. Dry with a soft cloth or a wet buff.

Do not:

- Use alcohol-based or highly alkaline detergents
- Use a dry cloth for dry dirt removal
- Clean of panels under direct sunlight or high temperatures.
- Use abrasives, squeegees, blades, pointed tools, roto-brush systems

For tables of surfaces chemical resistance, please refer to attachment 2.

4. PRODUCTS PROCESSING

GENERAL PROCESSING RECOMMENDATIONS

- Do not undergo mechanical processing onto panels before 10 days' from production.
- Avoid overheating the material: tools must be correctly sharpened, cleaned and not damaged.
- Use appropriate tool cooling systems (compressed air, water) in order to avoid material overheating which can cause formation of air light and chips, which are difficult to remove.
- Firmly anchor the pieces under processing in order to avoid the presence of vibrations, which can cause panel delamination, and tearing of covering sheets/layers/spalling of sheets.
- Keep equipment and pieces under processing clean: potential scales and/or flashes can be transmitted from tools/equipments and damage panel surface.
- Keep the protection film on as long as possible even during processing in order to avoid superficial abrasions during panel handling.
- During processing panels can become electro statically charged making the removal of chips difficult: the problem can be solved vacuum cleaning the chips and via anti static sprays.
- The heating of material due to machining and thermo forming can cause the release of fumes toxic for operators and potentially inflammable. Provide an adequate ventilation of the environments.

4.1. CUTTING WITH CIRCULAR SAW

Below are the cutting specifications advisable for the whole range of STARLIGHT and LIGHTBEN products. For more complete information, the specifications supplied by the raw material producers are also indicated.

4.1.1. CUTTING SPECIFICATIONS

Cutting machine: adopt a cutting machine with a disk and mobile track-blade, according to the scheme illustrated below; the machine should be equipped with a blade cooling system with vaporized water, a system with a disk rotation " V_t " speed and a system for the track-blade feed " V_a " speed regulation.

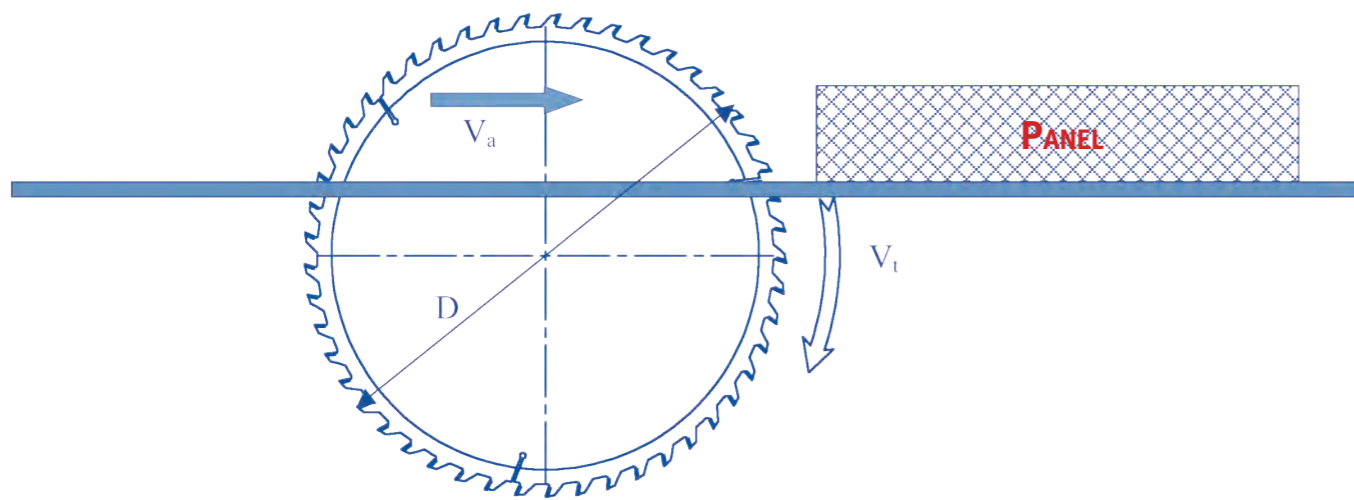

4. PRODUCTS PROCESSING

TOOL GEOMETRIES AND RECOMMENDED PARAMETERS

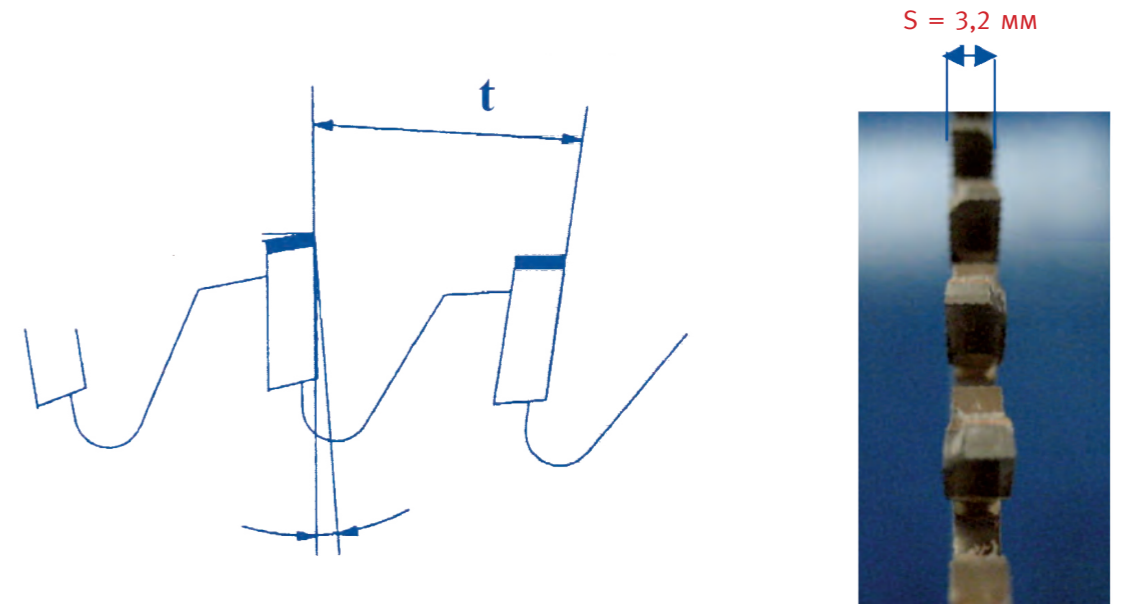

ALTERNATING SEMI-TRAPEZOIDAL SHAPE

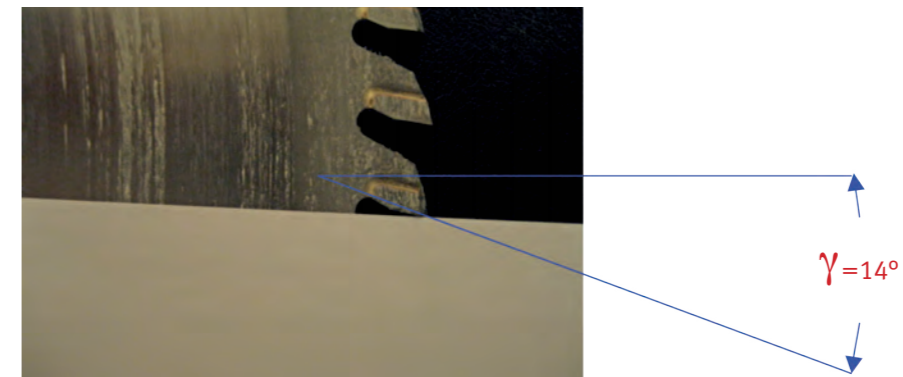

Main clearance angle (°) γ	14
Pitch/tooth spacing (mm) t	9.81
Thickness (mm) s	3.2
External diameter (mm) D	300
Teeth material:	Tungsten carbide
Disk rotation speed (rpm)	4.700
Cutting speed (m/min) V_t	4.427
Feed speed (m/min) V_a	STARLIGHT, STARLIGHT EXTRA, STARLIGHT PLUS FLOOR, STARLIGHT PLUS UVP, LIGHTBEN, LIGHTBEN PLUS UVP 30/40 STARLIGHT PLUS CLASS, LIGHTBEN PLUS 10/15

4. PRODUCTS PROCESSING

4.1.2. CUTTING SPECIFICATIONS RECOMMENDED BY RAW MATERIAL MANUFACTURERS

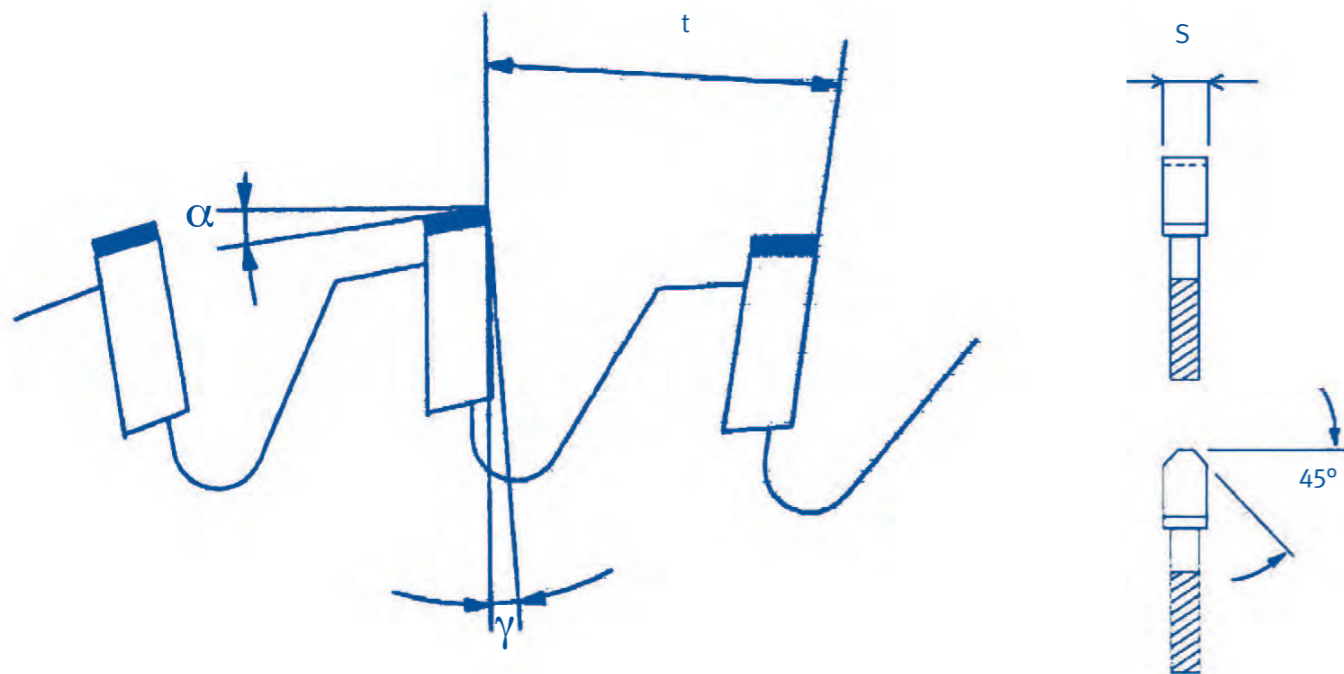
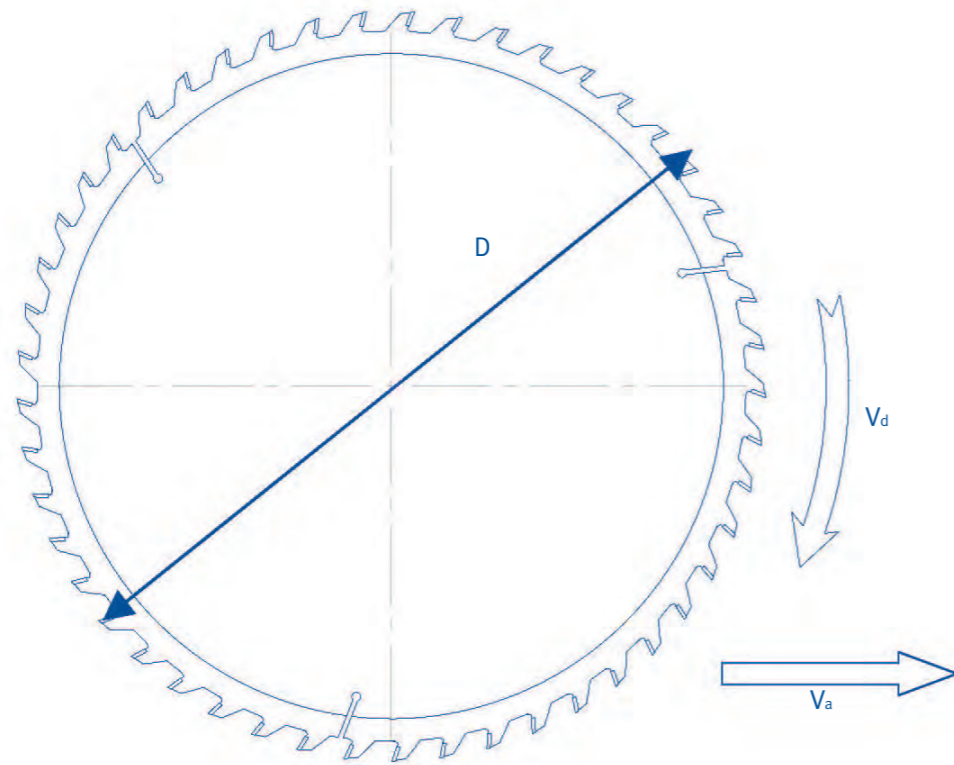

4. PRODUCTS PROCESSING

ALTERNATING SEMI-TRAPEZOIDAL SHAPE

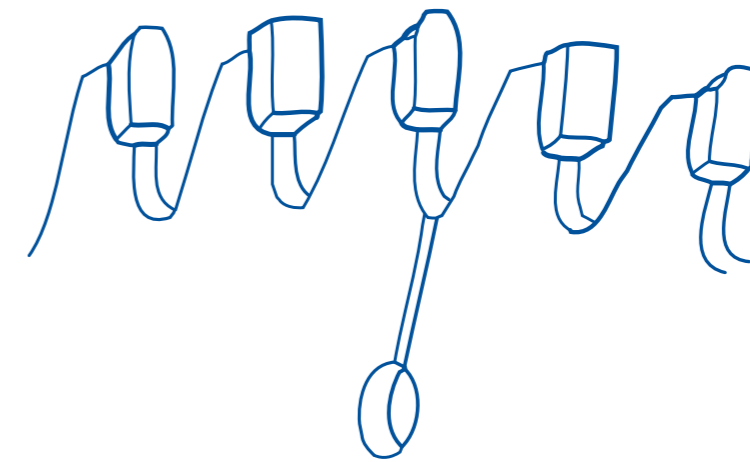

STARLIGHT- PLUS-UVP, LIGHTBEN- PLUS-UVP

Main clearance angle (°) γ	5÷15
Secondary clearance angle (°) α	10÷15
Pitch/tooth spacing (mm) t	8÷18
Thickness (mm) s	3÷4
External diameter (mm) D	200-400mm (larger diameters recommended)
Some recommended combinations external diameter / tooth number	200mm 80 teeth 250mm 60-80 teeth 300mm 60-80 teeth 350mm 60-80 teeth
Teeth material:	Tungsten carbide
Cutting speed (m/min) Vt	1800÷2400
Feed speed (m/min) Va	4÷6

4. PRODUCTS PROCESSING

STARLIGHT, STARLIGHT-EXTRA, LIGHTBEN

Teeth material:	Tungsten carbide (recommended for a long lasting sharpening) Superfast steel (recommended for a better finishing of cut edges)
Main clearance angle [°] γ	0 ÷ -5
Secondary clearance angle [°] α	10-15 (carbide teeth) 30-40 (carbide teeth)
Pitch/tooth spacing (mm) t	10 (carbide teeth) 5 (carbide teeth)
Thickness (mm) s	3-4
External diameter (mm)	200-400 mm (larger diameters preferable)
Cutting speed (m/min) Vt	≤ 3000
Feed speed (m/min) Va	4-6

STARLIGHT-PLUS-CLASS E LIGHTBEN- PLUS

Teeth material:	Tungsten carbide
Main clearance angle [°] γ	5÷15
Secondary clearance angle [°] α	10-30
Pitch/tooth spacing (mm) t	3 ÷ 11
Thickness (mm) s	3-4
External diameter (mm)	200-400 mm (larger diameters preferable)
Cutting speed (m/min) Vt	2500-6000
Feed speed (m/min) Va	3 3 ÷ - 15

4.1.3. TROUBLESHOOTING

PROBLEM	SOLUTIONS (adopt them according to the sequence supplied below until problem solved)
Residue formation due to material melting during cutting	<ul style="list-style-type: none"> • Check the correct alignment of the blade on the shaft. • Reduce cutting speed Vt • Increase cutting speed Va • Increase main clearance angle γ • Foresee a blade cooling system with nebulized air and water
Ragged cutting surfaces, rupture of skins, panel delamination.	<ul style="list-style-type: none"> • Check the correct blade tooth sharpness • Improve the panel anchoring to avoid vibrations. • Check the correct alignment of the blade on the shaft. • Increase cutting speed Vt • Decrease feed speed Va • Decrease main clearance angle γ

4. PRODUCTS PROCESSING

4.2. DRILLING

SPECIFICATIONS SUPPLIED BY RAW MATERIAL PRODUCERS

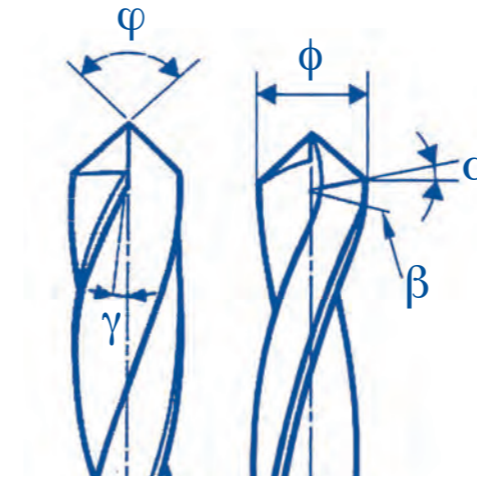

SPECIFICATIONS FOR STARLIGHT- PLUS- UVP, LIGHTBEN- UVP PANELS

Main clearance angle [°] γ	0÷4
Secondary clearance angle [°] α	3÷8
Cutting edge angle [°] ϕ	60÷90
Helix angle [°] β	12÷16
Cutting speed (m/min)	30÷50
Feed (mm/rev)	0.05÷0.3

SPECIFICATIONS FOR STARLIGHT, STARLIGHT EXTRA, LIGHTBEN PANELS

Main clearance angle [°] γ	0÷4
Secondary clearance angle [°] α	3÷8
Cutting edge angle [°] ϕ	60÷90
Helix angle [°] β	12÷16
Cutting speed (m/min)	30÷50
Feed (mm/rev)	0.05÷0.1

SPECIFICATIONS FOR STARLIGHT- PLUS- UVP, LIGHTBEN PANELS

Main clearance angle [°] γ	3÷5
Secondary clearance angle [°] α	3÷6
Cutting edge angle [°] ϕ	60÷90
Helix angle [°] β	12÷16
Cutting speed (m/min)	12÷25
Feed (mm/rev)	0.2

4. PRODUCTS PROCESSING

4.3. MILLING

In the STARLIGHT, EXTRA STARLIGHT PLUS CLASS, STARLIGHT PLUS FLOOR, STARLIGHT PLUS UVP milling in the core can be performed so as to house the slip beading/edging (see paragraph 4.4) and profile joint (see par. 4.5.). In this type of processing a joinery machine "ROUTER" type (see scheme) with an automated panel feed system is recommended; recommended tools and cutting parameters are described below.

MILLING EXECUTION SCHEME FOR PROFILE HOUSING

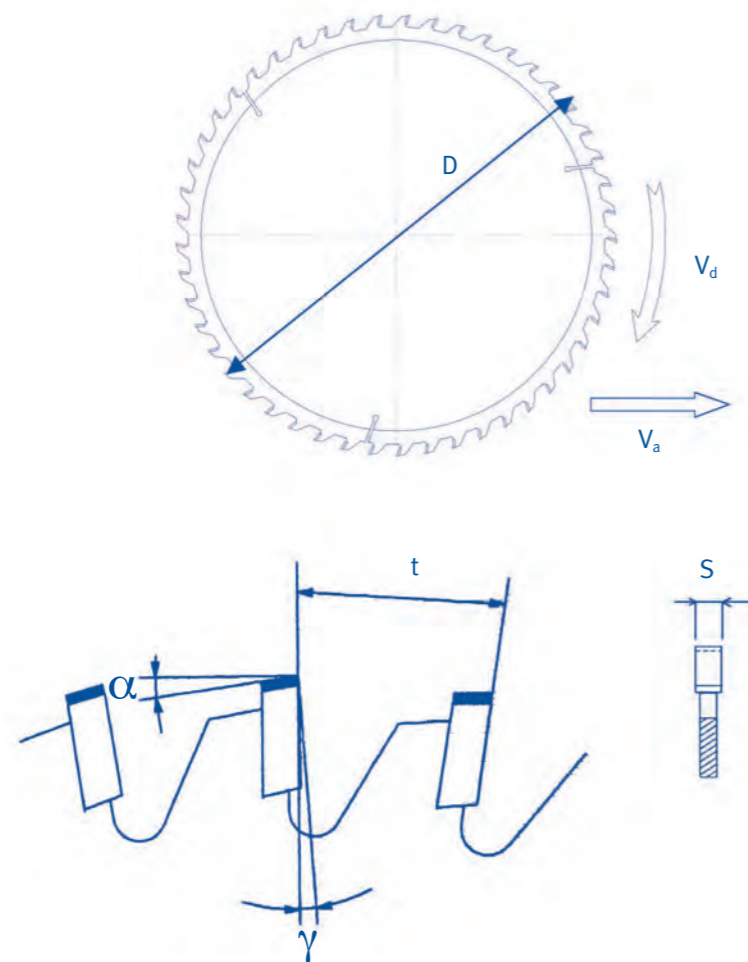
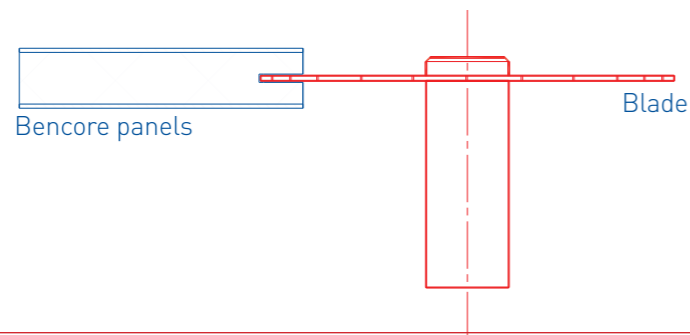

4. PRODUCTS PROCESSING

GEOMETRIES AND PROCESSING PARAMETERS FOR MILLING PERFORMANCE

Main clearance angle (°) γ	5 ÷ 15
Secondary clearance angle (°) α	10 ÷ -15
Pitch/distance between teeth (mm) t	9 ÷ 26
Thickness (mm) s	2-5
External diameter (mm)	200
Cutting speed (m/min) Vt	2500-6000
Teeth material:	tungsten carbide
Disk rotation speed (rev/min) Vd	6000
Feed speed (m/min) Va	16 ÷ 33

4.4. EDGING

Edging can be performed adopting the following different solutions indicated the table below, starting from the main aesthetically valid to the most convenient; see the following figures.

HIGHEST AESTHETICALLY VALID SOLUTIONS

EDGING SYSTEM	RECOMMENDED PRODUCTS	NOTE
Foil, even transparent edging; processing by hand/manual (figure 4.1)	STARLIGHT STARLIGHT-EXTRA LIGHTBEN	Best results are obtained edging, chamfering, and manually polishing the edges (see par. 4.6), and adopting the same material of the covering sheets for the border
Foil, even transparent, edging; machine processing (figure 4.2).	STARLIGHT E LIGHTBEN (all versions)	Use "pure melt" edging machines for wooden panels: aesthetically results slightly inferior to hand edging
Edging with "T" profiles housed in milled slot (see par. 4.3). Manual processing (figure 4.3)	STARLIGHT-EXTRA STARLIGHT-PLUS-CLASS STARLIGHT-PLUS-FLOOR	Fast, convenient and resistant system; in comparison to edging gives slightly inferior results. Edges can be made of different materials (metal, plastic, etc.)
Edging through housing of the panel in external profiles. (Figure 4.3)	STARLIGHT E LIGHTBEN (all versions)	This is the fastest, more convenient and resistant system. Edges can be made of different materials (metal, plastica, etc.)

ECONOMICAL SOLUTIONS

4. PRODUCTS PROCESSING

EDGING (MANUALLY OR BY MACHINE)



4. PRODUCTS PROCESSING

“T” PROFILE EDGING HOUSED IN MILLED SLOT



EDGING:

MANUALLY EDGED PANEL

MACHINE EDGED PANEL



EXTERNAL PROFILES



4. PRODUCTS PROCESSING

4.5. GLUING AND ASSEMBLING

The STARLIGHT (all types) and LIGHTBEN (all types) can be assembled one to the other and can be glued to other materials joining them at the covering sheets.

Reinforced joints can be made inserting transparent polycarbonate foils inside spots milled (see par. 4.3) in the panel (STARLIGHT EXTRA, STARLIGHT PLUS CLASS, STARLIGHT PLUS FLOOR and STARLIGHT PLUS UVP only).

Follow recommendations given here below:

In order to avoid panels from getting damaged, follow the adhesive compatibility table at the attachment 4.

For structural applications with glued joints, please consult Bencore's Technical office.

EXAMPLES OF GLUED JOINTS (ALL STARLIGHT AND LIGHTBEN PANELS)

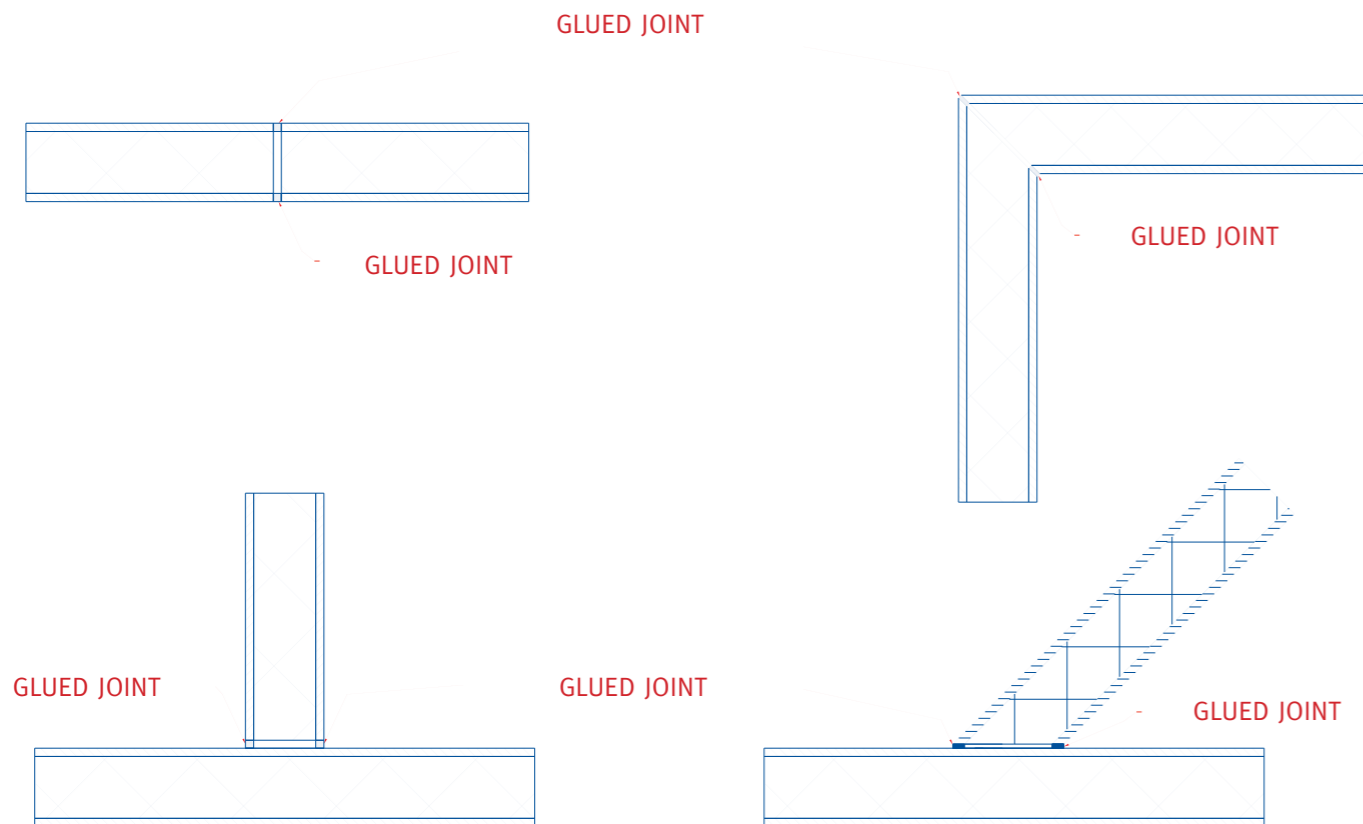

4. PRODUCTS PROCESSING

EXAMPLES OF GLUED JOINTS WITH POLYCARBONATE STRENGTHENING (STARLIGHT EXTRA STARLIGHT PLUS CLASS STARLIGHT FLOOR STARLIGHT UVP): panel preparation and processing cycle.

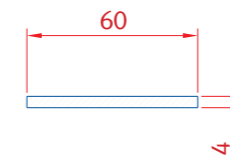
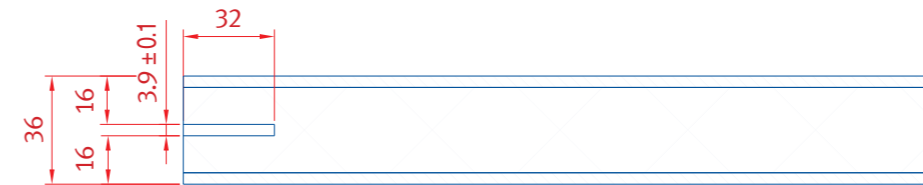
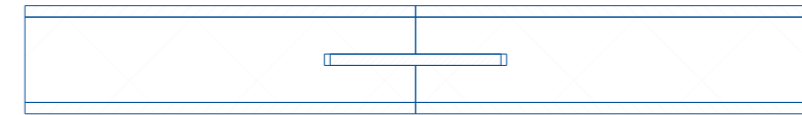

4. PRODUCTS PROCESSING

4.6. POLISHING

STARLIGHT and LIGHTBEN surfaces can be polished proceeding as follows:

- to restore original gloss of surfaces damaged by scratches or abrasions due to faulty repairs
- to finish surfaces deriving from cutting/milling operations, giving them a look very similar to those of the external sheets of the panel;
- to refine (give a final touch) after edging

To choose the most suitable panels for the polishing operations, please consult the table below

For the choice of the most suitable panels for polishing operations, please refer to the table below

POLISHING POSSIBLE WITH BEST RESULTS; THIS OPERATION CAN BE INSERTED IN THE PANEL PROCESSING CYCLE	POLISHING POSSIBLE WITH BEST RESULTS, TO BE FORESEEN FOR ACCIDENTAL PROBLEMS	POLISHING NOT RECOMMENDED
STARLIGHT, STARLIGHT-EXTRA, LIGHTBEN	STARLIGHT-PLUS-CLASS LIGHTBEN- PLUS	STARLIGHT- PLUS- UVP, LIGHTBEN- PLUS-UVP, STARLIGHT PLUS FLOOR

For detailed information, please consult the Bencore's Technical office.

POLISHING INSTRUCTIONS

Phase 1: removal of material up to the disappearance of processing scratches-marks.

Use a rotor-orbital polishing machine (orbit: mm) with speed regulation and rigid sanding disk diam. 150mm treating in succession the surfaces with abrasive paper grain (150, 240-360 (dry), abrasive 3M 260L P600 (dry) and abrasive 3M TRIZACT P1000 (wet)

Phase 2a: polishing (glossy surfaces)

Use an electronic polishing machine with speed regulation and sanding disk for sponges 3M09552 treating the surfaces as follows:

- Felt 3M 0358 and universal abrasive paste 3M 09375
- Orange sponge pad 3M 09550 WITH UNIVERSAL ABRASIVE PASTE 3M 09375

Phase 2b: polishing of matt surfaces:

For matte surfaces panels it is possible to carry out an opacifying treatment in alternative to polishing with a rotor-orbital (orbit mm) with speed regulation, rigid sanding disk diam. 150, 3M 02329, abrasive 3M TRIZACT P3000 (WET)

4.7. THERMOFORMING

Hot bending operations of panels such as STARLIGHT and STARLIGHT-PLUS-CLASS, LIGHTBEN and LIGHTBEN-PLUS-CLASS are possible with a bending radius not less than 20-25 times the thickness of the panel. It is recommended to consult the Bencore's Technical office.

4. PANEL PROCESSING

EXAMPLES OF THERMOFORMED STARLIGHT PANELS

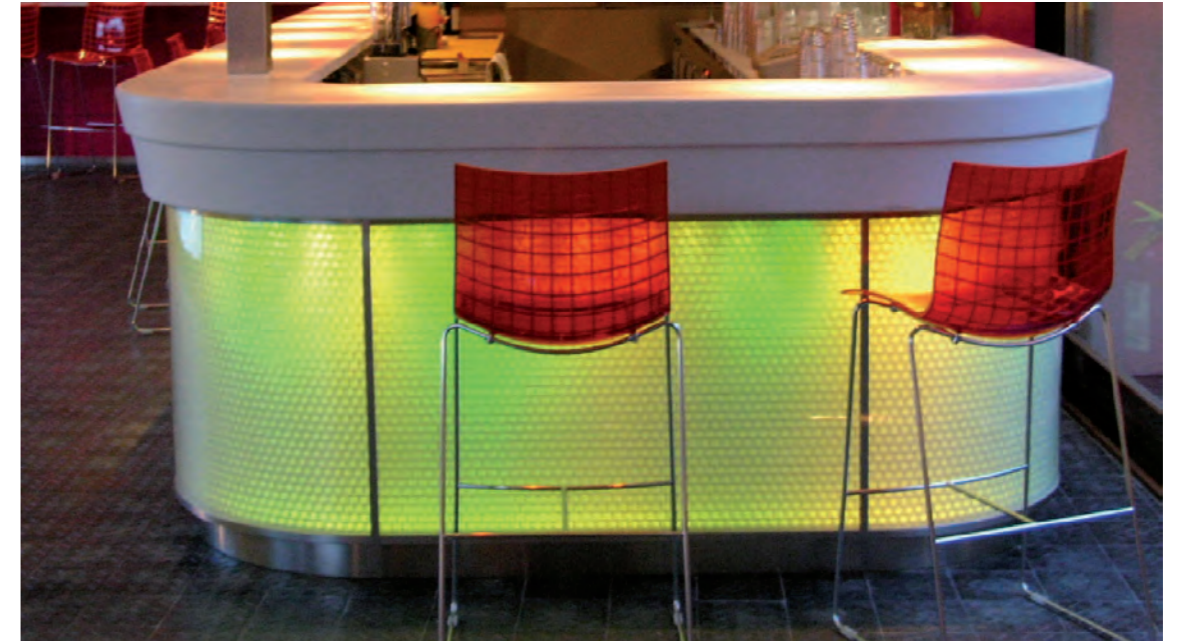

4. PRODUCTS PROCESSING

4.8. LASER AND WATER-JET CUTTING

Processings NOT RECOMMENDED for STARLIGHT and LIGHTBEN PANELS.

4.9. SEALING EDGES

If panels are exposed to weather conditions or if they are placed in very humid environments (such as bathroom, saunas, etc.) edges MUST be sealed with acid-free silicon protecting surfaces near the edges with masking cellar tape. Some possible solutions are given below

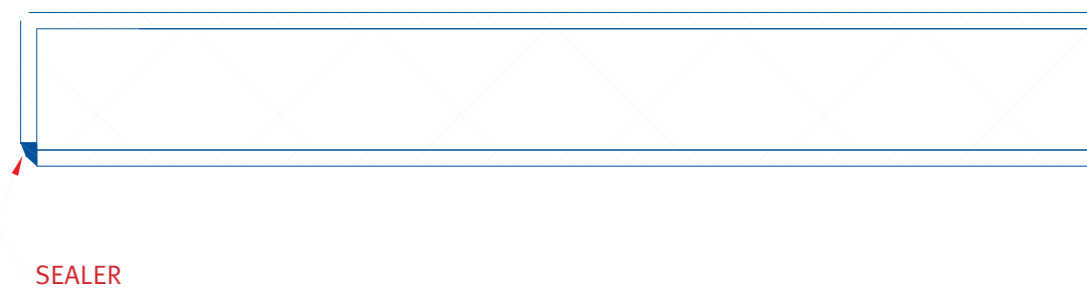
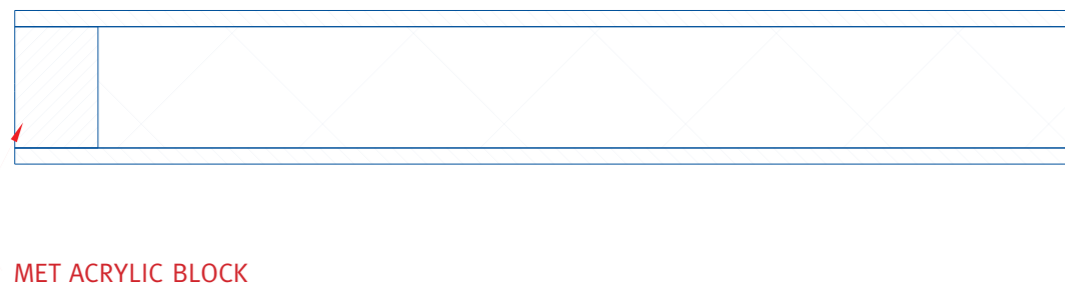

5. GUIDELINES FOR THE USE OF PANELS

5.1. OUTDOOR USE (VERTICAL PARTITIONS, ROOFS AND SKYLIGHTS)

Suggested materials for exteriors:

STARLIGHT or LIGHTBEN in double-glazed version.

These products are manufactured using STARLIGHT or LIGHTBEN core inside double-glazing.

For other application, feel free to contact Bencore Technical Office.

5.2. USE FOR RAISED FLOORS

Recommended materials: STARLIGHT- PLUS-FLOOR 40, installation and weight-capacity as per the technical data sheet in enclosure 1.

It is possible to also use STARLIGHT-PLUS and STARLIGHT-EXTRA panels. Please, consult Bencore if you intend to use Starlight Plus or Starlight Extra or to Bencore Technical Office for Mechanical Properties certifications.

5.3. USE FOR INDOOR HIGHLY-HUMID ENVIRONMENTS AND/OR IN PRESENCE OF VAPOUR

STARLIGHT (all types) and (LIGHTBEN (all types) can be used: foresee the insertion in metal/plastic frames and sealing of joints to avoid water seepage.

5.4. PANEL BACKLIT

STARLIGHT panels (all types) and LIGHTBEN (all types) can be backlit by neon lamps or LEDs.

Backlit with incandescent lamps or halogens is NOT recommended

5. GUIDELINES FOR THE USE OF PANELS

GENERAL SPECIFICATION FOR PANEL BACK LIGHTING

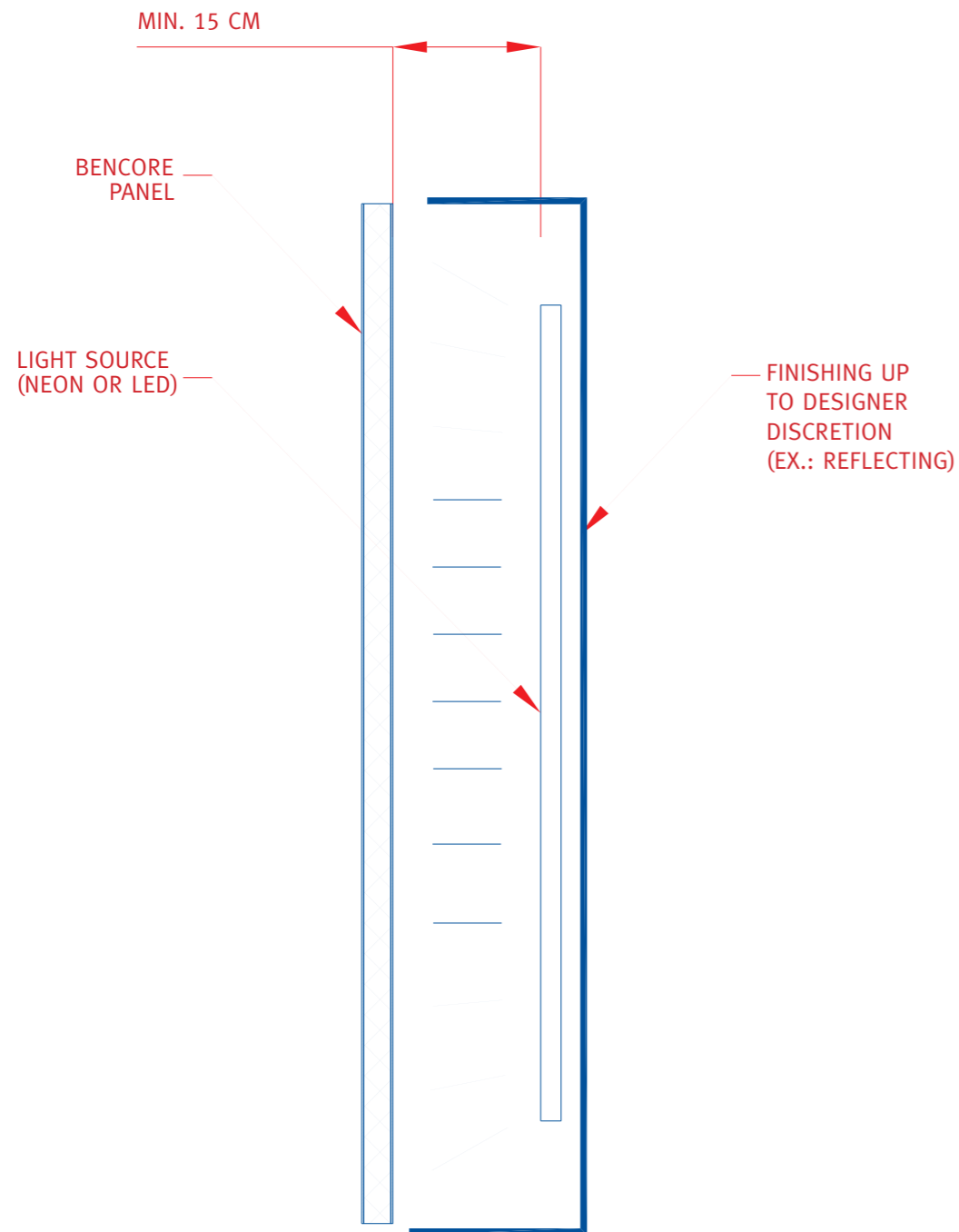

5. GUIDELINES FOR THE USE OF PANELS

EXAMPLE OF STARLIGHT PANEL BACKLIGHTING



5.5. FIRE-CLASS CERTIFICATIONS

In case of particular realizations/applications (for example in open to the public environments such as offices, exhibition stands etc.) the Local Authorities can ask for the use of panel with a fire certification; here below there is a table of Bencore products certification.

ITALY UNI 9177	STARLIGHT PLUS CLASS 34: Class 1
	LIGHTBEN PLUS 19; LIGHTBEN PLUS CC 19: Class 1
	STARLIGHT PLUS FLOOR 40: Class 1
GERMANY DIN 4102-1	STARLIGHT PLUS CLASS 19: Class B1
	STARLIGHT PLUS CLASS 36: Class B1
	LIGHTBEN PLUS 19; LIGHTBEN PLUS CC 19: Class B1
	LIGHTBEN PLUS 21 : Class B1

5. GUIDELINES FOR THE USE OF PANELS

5.6. MAKING FURNITURE COMPONENTS

5.6.1. SHELVES: DIMENSIONS AND LOADS

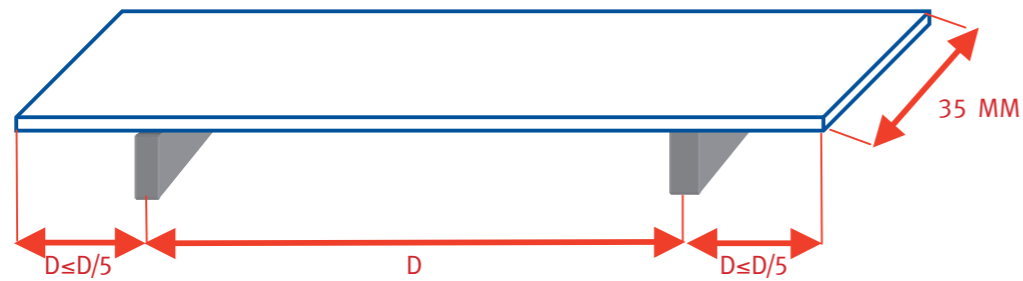

Find below the recommendations on load bearing capacity according to load and chosen material. Best results are obtained with STARLIGHT, STARLIGHT-EXTRA E LIGHTBEN panels, which are more suitable for edging, polishing and thermoforming process (see paragraphs 4.4, 4.5, 4.6, 4.7). Other types of panels give lower results.

MATERIAL	Advised supports span "D" with light load 15Kg/m	Advised supports span "D" with heavy load 40Kg/m
STARLIGHT 19 STARLIGHT EXTRA 19 STARLIGHT PLUS CLASS 19	90cm	65cm
STARLIGHT 21 STARLIGHT EXTRA 21	115cm	85cm
STARLIGHT 34 STARLIGHT EXTRA 34 STARLIGHT PLUS CLASS 34	140cm	100cm
LIGHTBEN 19 LIGHTBEN PLUS 19	75cm	55cm
LIGHTBEN 21 LIGHTBEN PLUS 21	80cm	60cm

5.6.2. COMPLEX STRUCTURES

Best result are obtained with STARLIGHT, STARLIGHT-EXTRA and LIGHTBEN panels that are more suitable for edging, gluing, polishing, thermoforming process (see paragraphs 4.4, 4.5, 4.6, 4.7). The other type of panels are more difficult to processing and can give lower esthetical results

5. GUIDELINES FOR THE USE OF PANELS

EXAMPLE OF COMPLEX FURNITURE



6. TROUBLESHOOTING

6.1. SCRATCHES-TEARS OF THE PROTECTIVE FILM

If during panels transportation or successive handling the protective film is removed or altered, damage to panel surfaces can occur. If it is necessary to remove the protective film to inspect the plastic surface, it is important to recover the surface with the film and to use a low adhesive tape to keep the film in place. If damages are present on the panel surface small scratches and abrasions can be removed through polishing (refer to paragraph 4.6)

6.2. PARTIAL DETACHMENT OF EXTERNAL SKIN

If the surface sheet separates from the core:
 Trimming: apply tape to the affected areas to prevent further delamination.
 Repairing: gently lift the detached skin (without causing a further detachment) and place a light layer of anglosol 2000 or ANGLO TC 731 adhesive (see attachment 4) over the core. Clamp the area to be repaired and allow approximately 2 hours for the adhesive to harden.

6.3. CONDENSATE INSIDE CORE CELLS

When STARLIGHT and LIGHTBEN panels are placed in environment at low temperature, even after edge sealing, condensate can occur inside the cells of the core. This phenomenon is not to be considered a panel defect, as it is transitory and tends to disappear when temperature increases.

7. SAFETY NOTES

STARLIGHT and LIGHTBEN panels are hard materials with cutting corners: use protective gloves and clothes during handling in order to avoid possible injury. In case panels are exposed to high temperatures (for examples, during mechanical processing, thermo formation, etc.) environments need to be adequately ventilated in order to avoid potential hazards due to gas formation, which could be potentially inflammable and dangerous for the operators. The material with which STARLIGHT and LIGHTBEN panels are formed tends to charge electrostatic and to suddenly emit electrical charges: therefore the presence of inflammable liquid or gases in the nearby areas has to be avoided.

For detailed information, please refer to the safety data sheets to be found in attachment 5.

8. ATTACHMENTS

ATTACHMENT 1 : PRODUCTS TECHNICAL DATA SHEETS

STARLIGHT

MECHANICAL PROPERTIES

	MODULUS OF ELASTICITY UNI-EN 310 (N/MM ²)	BENDING STRENGTH UNI-EN 310 (N/MM ²)	BENDING STIFFNESS (NXM ² /M)	COMPRESSIVE STRENGTH (N/MM ²)
Starlight / Starlight extra 19	1250	33	714,5	2,6
Starlight / Starlight extra 21	1790	33,1	1381,4	2,6
Starlight / Starlight extra 34	914	19,4	2993,7	2,1
Starlight / Starlight extra 36	1100	18,7	4276,8	2,1
Starlight plus class __ 19 Clear T / Clear S	1150	36	657,3	2,6
Starlight plus class __ 34 Clear T / Clear S	720	21	2358,2	2,1
Starlight plus floor 40	290	-	-	2,1
Starlight plus UVP T 21	1450	34	1119,0	2,6
Starlight plus UVP T 36	960	26	3732,5	2,1

	SUN ELEVATION ANGLE			
	0°	30°	45°	60°
Starlight plus UVP T 21	0,61	0,59	0,55	0,42

TSET-value (total energy solar transmittance)

STARLIGHT

MAXIMUM SUPPORT DISTANCES (MM)

	Load in N / m ²											
	600	800	1000	1200	1400	1600	1800	2000	2500	3000	3500	5000
Starlight / Starlight extra 19	1900	1750	1600	1500	1400	1350	1300	1250	1100	1000	950	
Starlight / Starlight extra 21	2000	2000	1950	1850	1750	1650	1600	1550	1450	1350	1250	
Starlight / Starlight extra 34	2000	2000	2000	2000	2000	2000	2000	2000	1850	1750	1650	1500
Starlight / Starlight extra 36	2000	2000	2000	2000	2000	2000	2000	2000	2000	1900	1850	1650
Starlight plus class __ 19 Clear T / Clear S	1800	1650	1550	1450	1350	1300	1250	1200	1050	950	900	
Starlight plus class __ 34 Clear T / Clear S	2000	2000	2000	2000	2000	2000	1900	1850	1700	1600	1500	1350
Starlight plus UVP T 21	2000	1950	1830	1700	1620	1550	1480	1420	1350	1250	1200	
Starlight plus UVP T 36	2000	2000	2000	2000	2000	2000	2000	2000	2000	1850	1800	1600

four sided simply supported square plate

safety factor > 3

deflection/edge < 1/50

8. ATTACHMENTS

STARLIGHT PLUS FLOOR S40 LOAD CAPACITY TABLE

DATA IN MM	support gap 500mm	support gap 600mm	support gap 1000mm
Deflection at a load of 2000N/m ² and four-sided-support	0,10	0,17	1,32
Deflection at a load of 2000N/m ² and two-sided-support	0,30	0,61	4,70
Deflection at a central load of 2000N and four-sided-support (*)	0,90	1,30	3,77
Deflection at a load of 3000N/m ² and four-sided-support	0,12	0,26	1,98
Deflection at a load of 3000N/m ² and two-sided-support	0,44	0,92	7,11
Deflection at a central load of 3000N and four-sided-support (*)	1,40	2,00	5,66
Deflection at a load of 4000N/m ² and four-sided-support	0,17	0,34	2,65
Deflection at a load of 4000N/m ² and two-sided-support	0,59	1,23	9,48
Deflection at a central load of 4000N and four-sided-support (*)	1,90	2,70	7,55
Deflection at a load of 5000N/m ² and four-sided-support	0,21	0,43	3,31
Deflection at a load of 5000N/m ² and two-sided-support	0,74	1,54	11,80
Deflection at a central load of 5000N and four-sided-support (*)	2,36	3,40	9,50

calculated data with safety factor >3

(*) the minimum application load surface must be >25 cm²

load capacity table

8. ATTACHMENTS

STARLIGHT LOAD CAPACITY TABLE 1000 N / M²

	500,0	600,0	750,0	1000
Starlight / Starlight extra 19	0,32	0,66	1,61	5,08
Starlight / Starlight extra 21	0,16	0,34	0,83	2,63
Starlight / Starlight extra 34	0,08	0,16	0,38	1,21
Starlight / Starlight extra 36	0,05	0,11	0,27	0,85

AREA LOAD 1000 N / M²

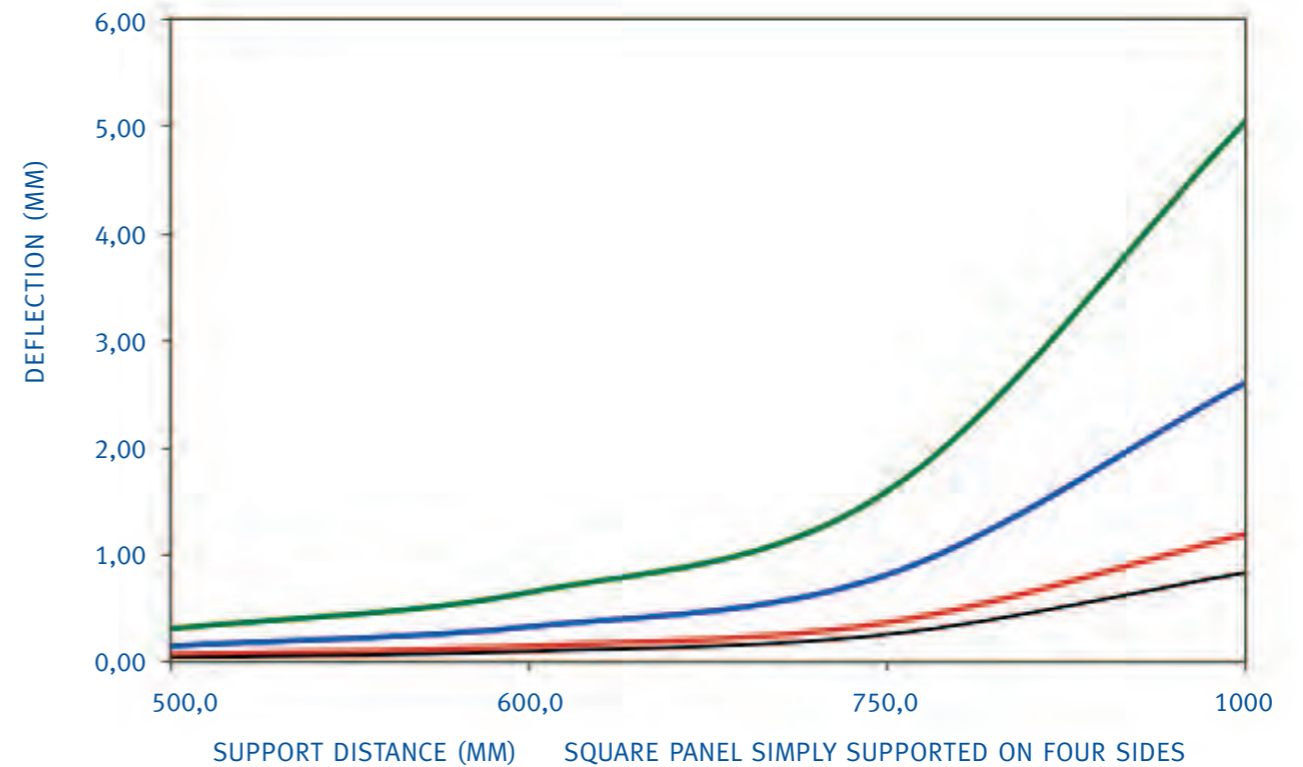

STARLIGHT / STARLIGHT EXTRA 19

STARLIGHT / STARLIGHT EXTRA 21

STARLIGHT / STARLIGHT EXTRA 34

STARLIGHT / STARLIGHT EXTRA 36

8. ATTACHMENTS

STARLIGHT

LOAD CAPACITY TABLE 3000 N/M²

	500,0	600,0	750,0	1000
Starlight Plus UVP T 21	0,61	1,26	3,08	9,73
Starlight Plus UVP T 36	0,18	0,38	0,92	2,92

AREA LOAD 3000 N / M²

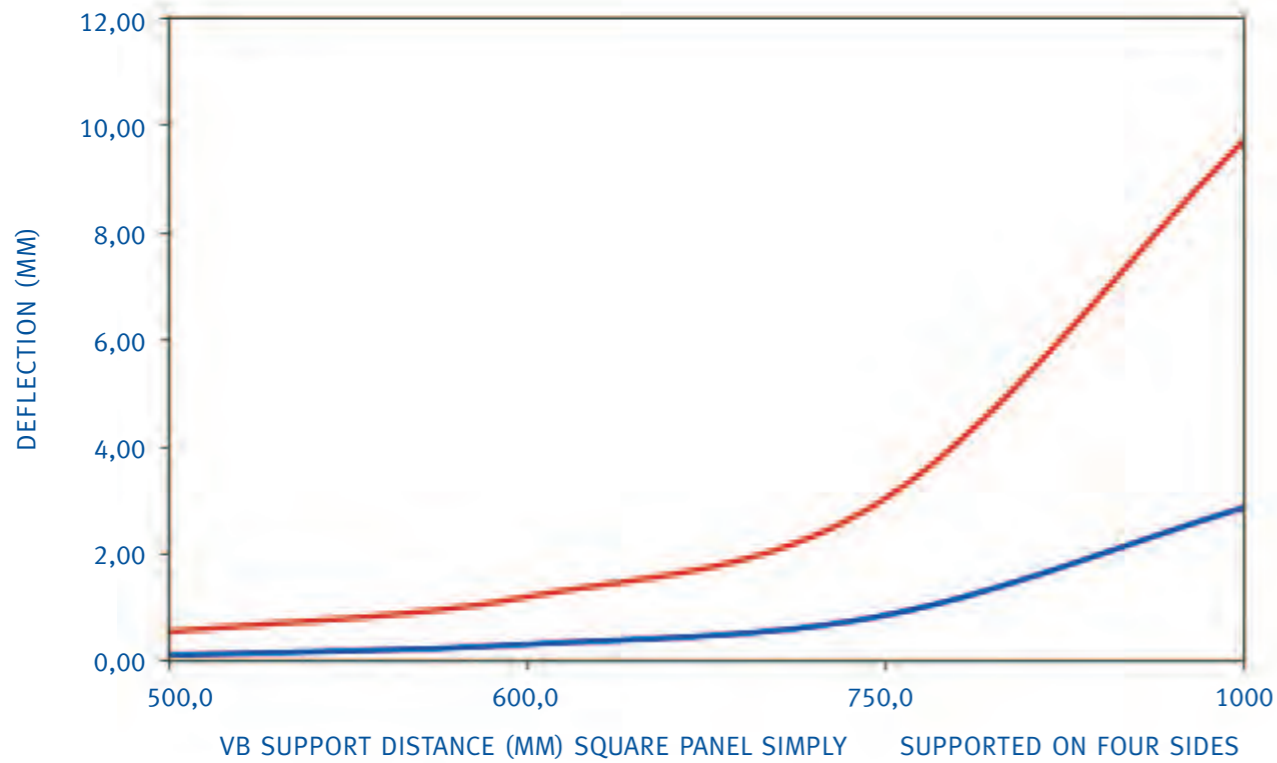

STARLIGHT PLUS UVP T 21

STARLIGHT PLUS UVP T 36

8. ATTACHMENTS

LIGHTBEN

TECHNICAL DATA

	standard panels			tolerances			others					
	length (mm)	width (mm)	thickness (mm)	length (mm)	width (mm)	thickness (mm)	fire class (DM 26/6/84 UNI 9177) ¹ (DIN 4102) ²	coefficient of thermal expansion (mm/m ^o K)	service temperature (°C)	weight per unit area (Kg/m ²)	thermal insulation U-value (W/m ² ·°K)	sound insulation Rw (db)
Lightben 19	3015	1000	19	±2	+1 / -2	±0,5%	-	0,065	-30° +80°	6	3	22
Lightben 21	3015	1000	21	±2	+1 / -2	±10%	-	0,065	-30° +80°	8,2	2,9	22
Lightben plus 19	3015	1000	19	±2	+1 / -2	±0,5%	class 11/B12	0,065	-30° +80°	6	3	22
Lightben plus 21	3015	1000	21	±2	+1 / -2	±10%	class 11/B12	0,065	-30° +80°	8,2	2,9	22
Lightben plus cc 19	3015	1000	19	±2	+1 / -2	±0,5%	class 11/B12	0,065	-30° +80°	6	3	22
Lightben plus cc 21	3015	1000	21	±2	+1 / -2	±10%	class 11/B12	0,065	-30° +80°	8,2	2,9	22

cc = coloured core

LIGHTBEN

MECHANICAL PROPERTIES

	modulus of elasticity UNI-EN 310 (n/mm ²)	bending strength UNI-EN 310 (n/mm ²)	bending stiffness (nxm ² /m)	compressive strength (n/mm ²)
Lightben / Lightben plus 19 / Lightben plus cc 19	700	22	400,1	1,0
Lightben / Lightben plus 21 / Lightben plus cc 21	850	25	656,0	1,0

8. ATTACHMENTS

LIGHTBEN

LOAD CAPACITY TABLE 1000 N / M²

Support distance	500,0	600,0	750,0	1000
Lightben / Lightben plus 19 / Lightben plus cc 19	0,40	0,90	2,00	6,20
Lightben / Lightben plus 21 / Lightben plus cc 21	0,32	0,70	1,60	5,00

AREA LOAD 3000 N / M²

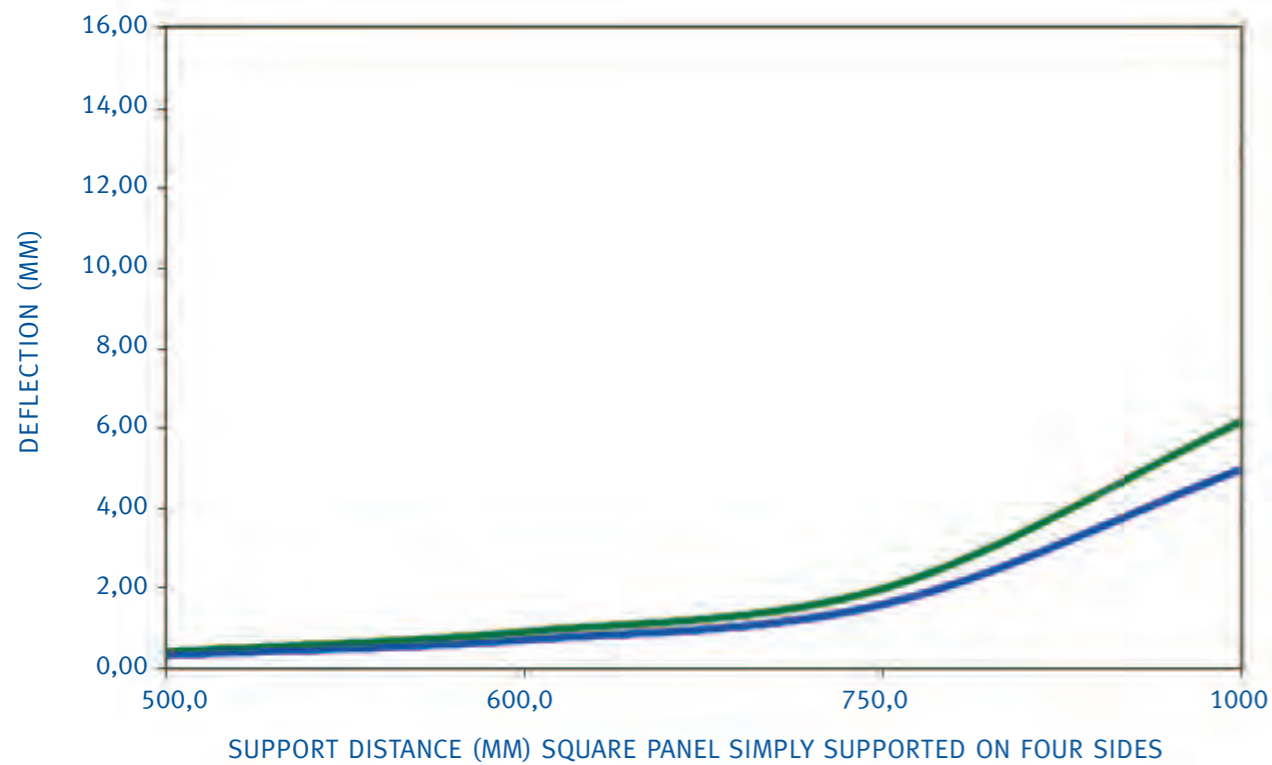

LIGHTBEN PLUS 19 

LIGHTBEN PLUS 21 

8. ATTACHMENTS

ATTACHMENT 2 : TABLES OF SURFACES CHEMICAL RESISTANCE

STARLIGHT-PLUS-CLASS AND LIGHTBEN- PLUS PANELS

Acetic Acid, 40% aq	1
Acetic Acid, glacial	3
Acetic Anhydride	4
Acetone	4
Aluminium Sulphate, solid	1
Ammonia, 10% aq	4
Ammonia, 0,88 SG aq	4
Ammonium Chloride, solid	1
Ammonium Persulphate, solid	1
Ammonium Sulphate, solid	2
Amyl Acetate	3
Amyl Alcohol	4
Amyl Methyl Ketone, solid	1
Barium Chloride, solid	1
Benzene, solid	4
Benzoic Acid	1
Benzyl Acetate	4
Benzyl Alcohol	4
Benzyl Benzoate	3
Butyl Acetate	4
Butyl Alcohol	1
Butyl Lactate	2
Butyl Stearate	1
Calcium Hypochloride, solid	2
Camphor, solid	1
Camphorated Oil	2
Carbon Tetrachloride	2
Castor Oil	1
Cetyl alcohol, solid	1
Chloral Hydrate, solid	4
Chlorobenzene	4
Chloroform	4
Chromic Acid, Plating Soln	4
Citric Acid	1
Citronellol	2
Cupric Sulphate, solid	1
Cyclohexane	1
Cyclohexanone	4
Cyclohexanol	2
Diacetone Alcohol	1
Di-alkyl Phthalate	1

LEGEND

1 = insensible - optimum chemical resistance.
 2 = satisfying, small distortions possible.
 3 = sufficient, decrease in the translucency possible.
 4 = insufficient, chemical attack with loss of initial characteristics.

Di-butyl Phthalate	1
Di-non Phthalate	2
Di-octyl Phthalate	1
Dimethyl Formamide	4
Dioxane	4
Dipentene	2
Di-1-phenyl Ethanol	3
Ethyl Acetate	4
Ethyl Alcohol	1
Ethyl Benzene	3
Ethyl Digol	1
Ethylene Chlorohydrin	4
Ethylene Dibromate	4
Ethylene Dichlorate	4
Eugenol	4
2-Ethoxy Ethanol	2
Ferric Nitrate, solid	1
Formaldehyde, 40% W/W aq	1
Formic Acid, 3 % aq	2
Formic Acid, 30 % aq	2
Furfuryl Alcohol	4
Geraniol	2
Glycerine	1
Glycol	1
Hydrobromic Acid, 50% aq	1
Hydrochloric Acid, 10% aq	2

8. ATTACHMENTS

Hydrofluoric Acid, 50% aq	3	Salicylic Acid, solid	1
Hydrofluoric Acid, 50% conc	4	Sodium Bicarbonate, solid	1
Hydrogen Peroxide	1	Sodium Borate, solid	1
Hydroquinone, solid	1	Sodium Bromide, solid	1
Isopropyl Alcohol	1	Sodium Carbonate, anhydrous	1
Lanoline	1	Sodium Carbonate, 2,5% aq	1
Linalol	2	Sodium Chloride, 1% aq	1
Linseed Oil	2	Sodium Chloride, 10% aq	2
Lubricating grease	1	Sodium Cyanide, solid	1
Magnesium Chloride, aq sol.	2	Sodium Hydroxide, 1% aq	4
Maleic Acid, 25% aq	2	Sodium Hydroxide, 10% aq	4
Maleic Acid, 50% aq	2	Sodium Nitrate, solid	2
Mercuric Chloride, solid	2	Sodium Phosphate, solid	1
Mercury	1	Sodium Sulphite, solid	2
Methyl Alcohol	1	Sodium Thiosulphate, solid	1
Methyl Cyclohexanol	1	Stearic Acid, solid	2
Methyl Ethyl Ketone	4	Sulphur, solid	1
Methyl Methacrylate	3	Sulphuric Acid, 3% aq	2
Methyl Salicylate	4	Sulphuric Acid, 30% aq	2
Methylene Chloride	4	Tartaric Acid, solid	2
Mineral Oil	1	Tetrahydrofuran	4
2-Methoxy Ethanol	3	Tetralin	1
Naptha, crude	1	Toluene	2
Naptha, solvent	2	Transformer Oil	2
Nitric Acid, 10% aq	2	Trichloroethyl Phosphate	1
Oil	1	Trichloroacetic Acid	4
Olive Oil	2	Trichloroethylene	4
Oxalic Acid, solid	1	Triethanolamine	4
Oxalic Acid, solution	2	Vinegar	2
n-Octane	1	Xylene	2
Paraffin (medicinal)	1	Zinc Chloride	2
Paraffin Oil	1		
Petrol	2		
Petroleum Ether	1		
Phenol	4		
Pinen	2		
Potassium Bromide, solid	1		
Potassium Chromate, solid	1		
Potassium Cyanide, solid	1		
Potassium Dichromate, solid	1		
Potassium Hydroxide, 1% aq	4		
Potassium Hydroxide, 10% aq	4		
Potassium Permanganate, sol.	3		
Propionic Acid	4		
Propyl Alcohol	1		
Propylene Glycol	1		

8. ATTACHMENTS

STARLIGHT, STARLIGHT-EXTRA, LIGHTBEN PANELS

PRODUCT	%	REACTION	PRODUCT	%	REACTION
ACIDS					
Acetic Acid	10	LA	Lactic Acid	20	NA
Acetic Acid	100	SA	Nitric Acid	10	
Butyric Acid	Concentr.	SA	Nitric Acid	Concentr.	
Chromic Acid	10		Oxalic Acid	Saturated	NA
Chromic Acid	Saturated	SA	Paracetic Acid		SA
Citric Acid	Saturated	NA	Phosphoric Acid	10	NA
Formic Acid	10	NA	Phosphoric Acid	95	SA
Formic Acid ^{concentr.}	90	SA	Sulfuric Acid	10	NA
Hydrochloric Acid	10	NA	Sulfuric Acid	30	LA
Hydrofluoric Acid	Concentr.		Sulfuric Acid	90	SA
Hydrofluoric Acid		SA	Tartaric Acid	Saturated	NA
ALCOHOLS					
Amyl Alcohols	Pure	SA	Methyl Alcohol	10	NA
Benzyl Alcohol	Pure	SA	Methyl Alcohol	50	LA
Butyl Alcohol	Pure	SA	Methyl Alcohol	Pure	SA
Ethyl Alcohol	30	SA	Propyl Alcohol	10	LA
Ethyl Alcohol ^{Anhydrous}	Pure	SA	Propyl Alcohol	50	SA
Ethyl Alcohol ^{Bzcontact}	10	NA			
BASES					
Caustic Potash	10	LA	Caustic Soda	50	SA
Caustic Potash	50	SA	Sodium Carbonate	Saturated	NA
Caustic Soda	10	LA			
GASES					
Acetylene		NA	Ozone		NA
Butane		NA	Propane		NA
Carbonic Gases		NA	Sulphur Dioxide		NA
Hydrogen		NA	Sulphuric Anhydride		SA
Oxygen		NA			
OILS AND GREASY PRODUCTS					
Butyl Stearate			Mineral Oils		NA
Coconut Oil		LA	Paraffin		NA
Lanoline		NA	Sodium Oleate		LA
Lockeed Oil		SA			
FOOD PRODUCTS					
Fruits Juices		NA	Vinegar		NA
Milk		NA	Wine		NA
Olive Oil		NA			

NA - No Attack
LA - Limited Attack
SA - Severe Attack

8. ATTACHMENTS

PRODUCT	%	REACTION	PRODUCT	%	REACTION
PHENOLS					
Cresol		SA	Phenol		SA
Metacresol		SA			
DISINFECTANTS AND CLEANING AGENTS					
Ammonia Solution	Density 0,88	NA	Hydro ⁹⁹ Peroxide	40 volumes	NA
Ammonium Solution	Concentr.	SA	Hydro ⁹⁹ Peroxide	90 volumes	SA
Bleach	10° Chlorine	NA	Mercurochrome		NA
Bleach	48° Chlorine	SA	Tincture of Iodine		SA
Formaldehyde	40	NA			
MINERAL SALTS IN SOLUTION					
Alun (Saturated Solution)		NA	Mercuric	10	SA
Ammonium Chloride	Saturated	NA	Potassium Bichromate	10	NA
Ammonium Nitrate		NA	Potassium Chloride	Saturated	NA
Calcium Chloride	Saturated	NA	Potassium Iodide		NA
Calcium Hypochloride		NA	Potassium Permanganate	10	NA
Chlorine Water	2	LA	Sea Water		NA
Copper Sulphate		SA	Sodium Bichromate	10	NA
Ferric Chloride	10	NA	Sodium Bisulphate	10	NA
Iron Perchloride		SA	Sodium Chloride		NA
Iron Sulphate		NA	Sodium Metaphosphate		NA
SOLVENTS AND MISCELLANEOUS					
Acetal Dehyde	100	SA	Ethylene Glycol		NA
Acetic Anhydride		LA	Ethylene Sulphate		SA
Acetone		SA	Freon		SA
Aniline		SA	Gasoil		LA
Benzene		SA	Glycerine		NA
Benzaldehyde		SA	Mercury		NA
Butyl Acetate		SA	Methylene Chloride		SA
Butyl Phthalate		LA	Methylethylketone		SA
Carbon Disulphide		SA	Naphtalene		LA
Chloroform		SA	Nonyl Phthalate		LA
Cyclohexane		SA	Petrol Standard		LA
Dichloroethane		SA	Petrol Super 100 Oct.		SA
Diethyl Chloride		SA	Pyraline		SA
Diethylene Glycol		NA	Turpentine		NA
Diethyl Phthalate		LA	Toluene		SA
Dioxane		NA	Trichlorethane		SA
Ethylamine		SA	Trichlorethylene		SA
Ethyl Acetate		SA	Tricresyl Phosphate		SA
Ethyl Chloride		SA	Xylene		SA
Ethyl Ether		SA	White Spirit (< 3% Aromatics)		NA

NA - No Attack
LA - Limited Attack
SA - Severe Attack

8. ATTACHMENTS

REAGENT	TIME TO SEE EXPOSURE EFFECTS
Methylene Chloride	1 min. (D, W)
Toluene	1 min. (D, W)
Solvesso 100	4 hrs. (W)
Kerosene	1 week (D, W)
Acetone	1 min. (D, W)
Oxalic Acide, solution	1 week
Hydrochloric Acid, concentrated	1 week (S, W)
Nitric Acid, concentrated	1 week (Y)
Sodium Hydroxide, saturated solution	48 hrs. (W)
Ammonium Hydroxide, concentrated	1 week

Note: Appearance of plastic after exposure: **S** = Slight, **W** = Whitening, **C** = Cracking, **Y** = Yellowing, **D** = Dissolution

chemical compatibility summary

Chemical class	Effects
Acids (Mineral)	No effect under most conditions of concentration and temperature. Generally compatible.
Alcohols	Acceptable at low concentration and temperature. Higher concentrations and temperatures result in etching and attack as evidenced by decomposition.
Alkalis	Generally compatible.
Aliphatic Hydrocarbons	Surface crystallisation and chemical attack.
Amines	Solvents and severe stress-cracking agents.
Aromatic Hydrocarbons	Mild soap solutions are compatible. Strongly alkaline ammonia materials should be avoided.
Detergents and Cleaners	Cause severe crystallisation. Partial solvents. Compatible at low stress levels. Some concentrates not recommended.
Esters	Not compatible at elevated temperatures and stress levels.
Fruit Juices and Soft Drinks	Pure petroleum types generally compatible. Many additives used with them are not, thus materials containing additives should be tested.
Gasoline	Solvents and severe stress-cracking agents. Cause severe crystallisation and stress-cracking. Solvents.
Greases and Oils	Generally compatible up to 80°C.
Halogenated Hydrocarbons	
Ketones	
Silicone Oils and Greases	

Chemical Resistance Tests

Chemicals	Uncoated PC
Toluene	W/S
Acetone	S
Methylethylketone	S
Dichloromethane	W/S
Sulphuric acid (95-97%)	ok
Hydrochloric acid (32%)	ok
Ammonia (25%)	ok
Thinner (Sikkens 1-2-3)	W/S
Super Gasoline (Esso)	W/S
Diesel Fuel (Esso)	ok
Fuel C	ok
Hairspray	ok

W = surface whitening
S = surface dissolution

8. ATTACHMENTS

ATTACHMENT 3 : ADHESIVES COMPATIBILITY

HEREINAFTER A LIST OF SUGGESTED ADHESIVES WHICH CAN BE USED WHEN BONDING BENCORE PRODUCTS ACCORDINGLY TO PANEL TYPE.

PANEL	ADHESIVE MANUFACTURER	ADHESIVE TRADE NAME
STARLIGHT - PLUS - CLASS and LIGHTBEN - PLUS	Rohm & Co. GmbH KG	Acrifix®
	Anglo Adhesives Ltd	Anglosol® 1200 Anglosol® 2000 Anglo® Extru-fix Anglo® Tc 731 Anglo® Tu 1908 Anglo® Ta 431
STARLIGHT, STARLIGHT EXTRA and LIGHTBEN	Rohm & Co. GmbH KG	Acrifix® 190 Acrifix® 192 Acrifix® 106 Acrifix® 108 Acrifix® 109 Acrifix® 116
	Anglo Adhesives Ltd	Anglosol® 700 Anglosol® 1200 Anglosol® 2000 Anglo® Cast-fix Anglo® Extru-fix Anglo® Cement 3 Anglo® Tc 731 Anglo® Tu 1908 Anglo® Ta 431
STARLIGHT - PLUS - UVP, LIGHTBEN - PLUS - UVP, STARLIGHT PLUS FLOOR	Rohm & Co. GmbH KG	Acrifix® 118 Acrifix® 200 Acrifix® 108 Acrifix® 190
	Anglo Adhesives Ltd	Anglosol® 1200 Anglosol® 2000 Anglo® Cast-fix Anglo® Extru-fix Anglo® Tc 731 Anglo® Tu 1908 Anglo® Ta 431

For products description, technical data sheets and applications please, visit the following internet sites: www.rohacell.com/en/Plexiglas and www.anglo-adhesives.co.uk/markets.html.

8. ATTACHMENTS

ATTACHMENT 4 : SAFETY DATA SHEETS

1. ELEMENTS IDENTIFICATORS OF SUBSTANCES/ PREPARATION AND OF THE COMPANY/ENTERPRISE

Manufacturer: BENCORE SRL
 Chemical denomination: Polymer-based materials
 Use: Sandwich panels for structural and architectural applications

2. COMPOSITIONS/INFORMATION ON INGREDIENTS

The product is mainly composed of polymers having a high molecular weight: copolymer styrene-acrilonitrile: around 40%, polimetil-metalcrlate around 60%, other components present in quantities inferior to 1%

3. IDENTIFICATION OF HAZARDS

The products is not to be held as hazardous

4. FIRST-AID MEASURES

EYE CONTACT
 The product can only cause mechanical irritations (abrasions or contact with dust); wash with clean water for 15 minutes, if irritation persists please contact a doctors.

SKIN CONTACT
 The products are not harmful in case of skin contact, but may cause wounds or excoriations by mechanical contact with the skin. In case of contact with melted material, rinse immediately with plenty of cool water and seek medical advice. Do not try remove the melted material once cooled on the skin.

INHALATION
 Material dust can cause respiratory (breathing) irritations: in that case, move the patient from polluted area and seek medical advice

INGESTION
 The product is physiologically inert, and there fore no first-aid medical treatment is required.

5. ANTI FIRE MEASURES

PROPER EXTINGUISHING MEANS
 water, foam, chemical dust, carbon dioxide

HAZARDOUS COMBUSTION PRODUCTS
 Intense smoke made of steam, carbide mono and bioxide, vapours containing low grade of polymers and derivatives of their sedation.

FIREMEN PROTECTION
 Wear a special indiviual protective equipment with respirator.

ELECTRIC DISCHARGES
 The product may cause electrostatic discharges.

8. ATTACHMENTS

6. SAFETY MEASURES IN CASE OF ACCIDENTAL LEAKAGE

Collect and if possible re-use. Alternatively recycle or dispose according to local country regulation.

7. HANDLING AND STOCKING

HANDLING	Refer to industrial standards for safety and health precautions.
STOCKING	Stock the product in a close environment at temperatures between +5 °C and + 40 °C avoiding direct solar heating, rain or snow exposure, presence of inflammable, corrosive agents and/or solvents.

8. EXPOSURE CONTROL/ PERSONAL PROTECTION

ENGINEERING CONTROLS	Under normal circumstances it is sufficient a good aeration of the stocking phase; in case of mechanical or warm processing, a continuous supply of fresh air to the workplace together with removal of processing fumes through exhaust system is recommended.
SAFETY EQUIPMENT	Protect with mask in case of mechanical processing.
RESPIRATORY PROTECTION	In case of machine of warm processing, if no sufficient ventilation is assured, use gas or dust protection masks.
SKIN PROTECTION	In case of manual handling, wear long pants, long sleeves and gloves to avoid cuts and abrasions caused by cutting edges of the product.
EYES PROTECTION	Wear safety-glasses with side shields or chemical goggles during cutting, drilling and operations on machineries.

9. PHYSICAL AND CHEMICAL PROPERTIES

Look	Panel with macro-cellular core light reflecting
Smell	None
Boiling Point	N/A
Vapour pressure	N/A
Vapour density (Air =1)	N/A
Interval of fusion (°C)	N/A 90-130
% volatiles	N/A
Water solubility	Insoluble
Decomposition temperature (°C)	> 300
Point of flammability (°C)	> 385
Slft-ignition point (°C)	> 450

8. ATTACHMENTS

10. STABILITY

The product is stable and inert under normal conditions of handling and stockage.

CONDITIONS TO AVOID	High temperatures (see section dedicated to physical and chemical properties)
HAZARDOUS DECOMPOSITION PRODUCTS	Processing fumes evolved at recommended processing conditions may include hydrocarbon elements.

11. TOXICOLOGICAL INFORMATION

With a correct use, according to the indications contained in the present card, the product has no hazardous effects on people's health.

12. ECOLOGICAL ACTIONS

The product should not cause environment degradation as it is water non soluble and non biodegradable.

13. CONSIDERATIONS ON DISCHARGING

INCINERATIONS	The thermal destruction with gaining of energy is possible by adapt incinerators.
RECYCLING	The materials making up the product are recyclable after mixing with verging material.
WASTE DISPOSAL	To be avoided whenever recycling or incineration are possible; the material is stable and inert under normal circumstances and it can be discharged in a landfill without destroying its stability and without danger of contamination of water sheet.

14. TRANSPORT INFORMATIONS

The product is not dangerous during transportation: no classification

15. INFORMATION ON THE REGULATIONS

Exemple of the obligation of tagging according to EEC directions

16. OTHER INFORMATION

NA



Bencore srl Via S. Colombano 9, 54100 Massa (ITALY) Tel. 0039-0585-834449

