

S Y S T E M S

 **bencore**[®]
COMPOSITE PANELS FOR ARCHITECTURE





SISTEMA ZERO / SYSTEM ZERO

Bencore presenta un sistema di parete modulare completo di porta, pensato sia per spazi domestici (partizioni interne, cabine armadio) che professionali (negozi, uffici, stand, alberghi ecc.), che reinterpreta la luce come elemento fondamentale degli interni contemporanei.

Questo sistema impiega un profilo in alluminio disponibile in una vasta gamma di colori RAL da abbinare alla collezione di pannelli Bencore (Starlight, Lightben, Hexaben, Ecoben). La struttura metallica è facilmente adattabile alle esigenze dimensionali degli spazi da dividere garantendo ampia libertà progettuale e semplicità di installazione.

Il sistema Bencore consente di adattarsi alle esigenze più disparate.

Acquistabile anche come singolo modulo, la parete e la porta ad anta battente possono essere forniti ad altezze variabili da 2,10 mt fino a 3 mt in un unico pannello senza giunzioni o sopra luce per la porta.

Facile da installare, il sistema Bencore può essere inserito in una parete preesistente di altro materiale (muratura, legno o cartongesso), o per realizzare una parete da pavimento a soffitto fino ad un'altezza di 3 mt.

Bencore presents a Modular System of walls and doors designed for domestic and professional spaces, reinterpreting light as the main element in contemporary interiors.

The System uses an aluminum profile available in a wide range of RAL colours to match Bencore product Collection (Starlight, Lightben, Hexaben, Ecoben). The metal structure can easily fit any dimensional need, allowing design freedom in definition of spaces together with easy installation.

Bencore System is extremely versatile and offers the possibility to personalize interiors in a wide range of configurations: from single-module wall, to multiple-modules wall with or without the door, available from 2,10 up to 3 meters heights. Easy to install, Bencore System can fit any existing wall (masonry, wood, plasterboard) and can be used for a floor-to-ceiling wall up to a 3 mt height.



SISTEMA ZERO / SYSTEM ZERO

PORTA E MODULI PARETE / DOOR AND WALL MODULES

2100 mm

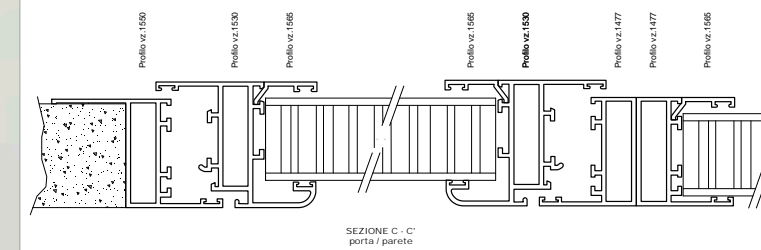
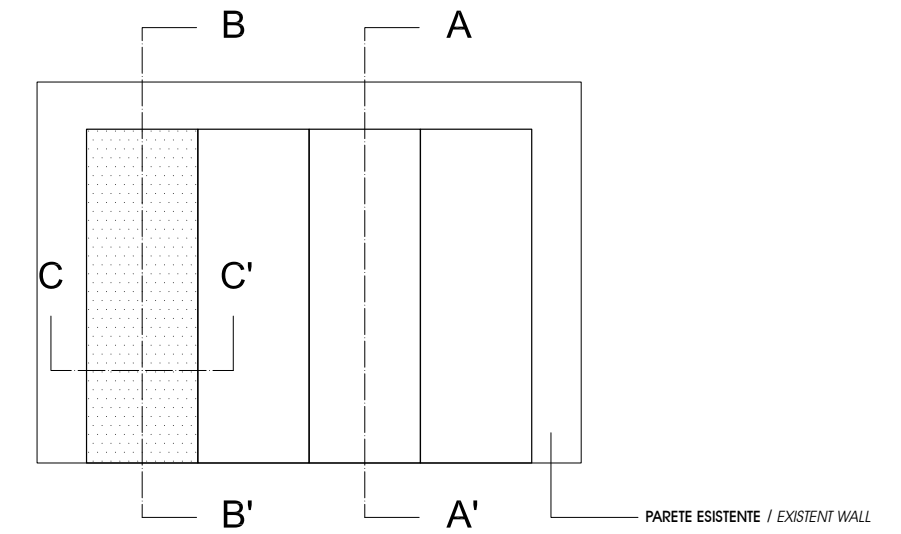
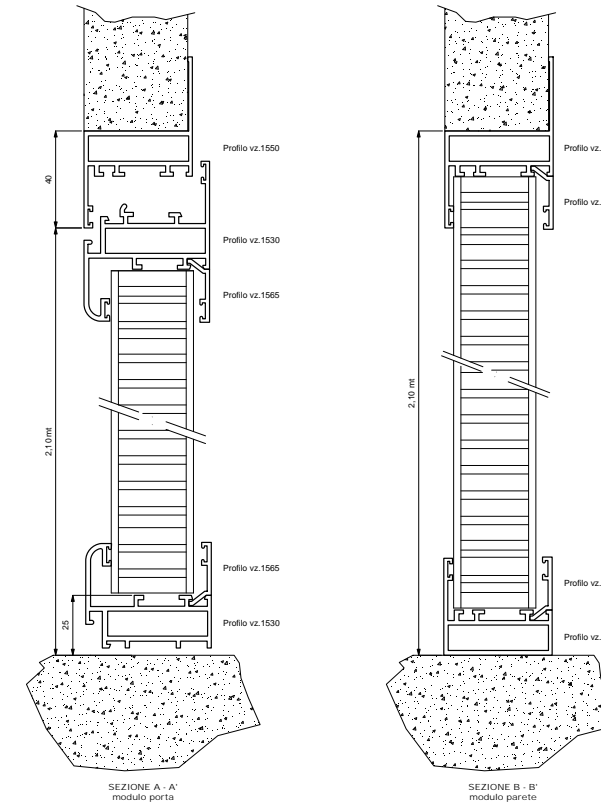

H = 2100

PANNELLO BENCORE BENCORE PANEL	723 x 2055	
N° 2 PANNELLI PARETE N° 2 WALL MODULES	1000 x 2060	
ALLOGGIAMENTO NEL MURO WALL HOUSING	1880 x 2140	
CODICI PROFILI PROFILE CODES	VZ 1477 telaio / frame - VZ 1530 porta / door VZ 1565 / 1552 / 1553 ferma vetro / glass stopper	
ACCESSORI ACCESSORIES	guarnizione - maniglia - cerniere gasket - handle - hinge	
COLORI STANDARD INFISSO FRAME STANDARD COLOURS	bianco - nero - argento white - black - silver	



SISTEMA ZERO / SYSTEM ZERO

PORTA E MODULI PARETE / DOOR AND WALL MODULES

2700 / 3050 mm

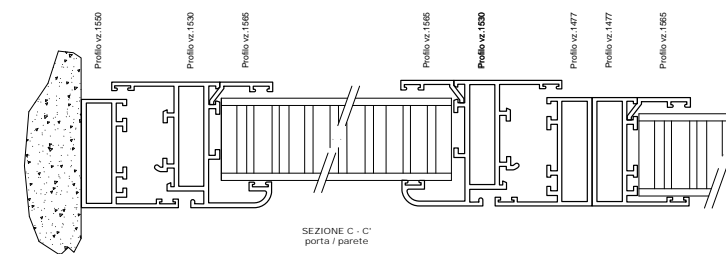
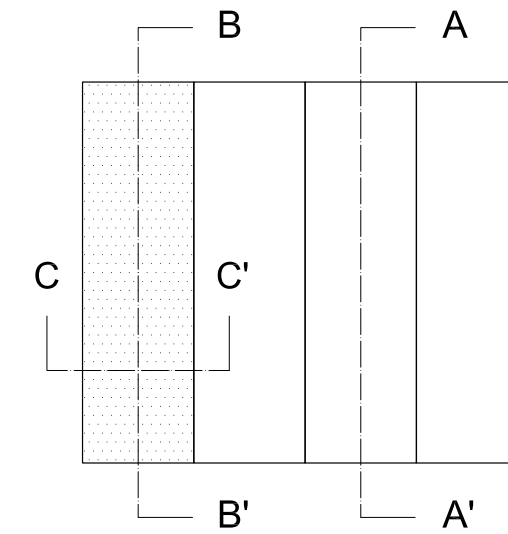
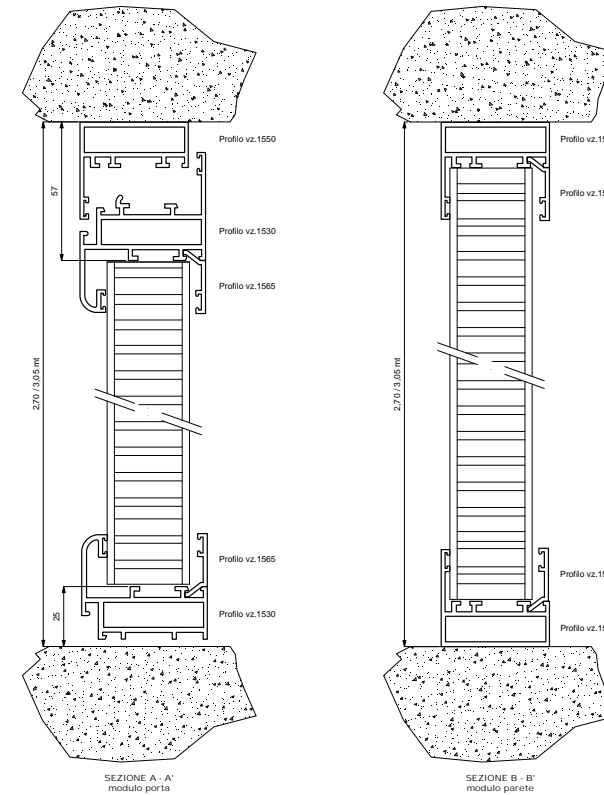

	H = 2700	H = 3000
PANNELLO BENCORE BENCORE PANEL	723 x 2615	723 x 3000
N° 2 PANNELLI PARETE N° 2 WALL MODULES	1000 x 2660	1000 x 3000
ALLOGGIAMENTO NEL MURO WALL HOUSING	2888 x 2700	2888 x 3152
CODICI PROFILI PROFILE CODES	VZ 1477 telaio / frame - VZ 1530 porta / door VZ 1565 / 1552 / 1553 ferma vetro / glass stopper	
ACCESSORI ACCESSORIES	guarnizione - maniglia - cerniere gasket - handle - hinge	
COLORI STANDARD INFISSO FRAME STANDARD COLOURS	bianco - nero - argento white - black - silver	



SISTEMA ZERO / SYSTEM ZERO

PARETE / WALL

2100 mm

ALTEZZA PARZIALE / PARTIAL HEIGHT

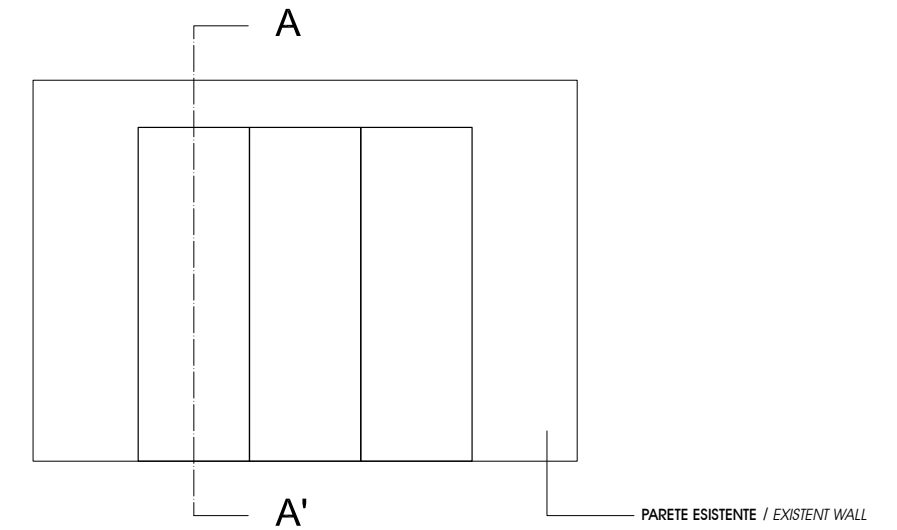
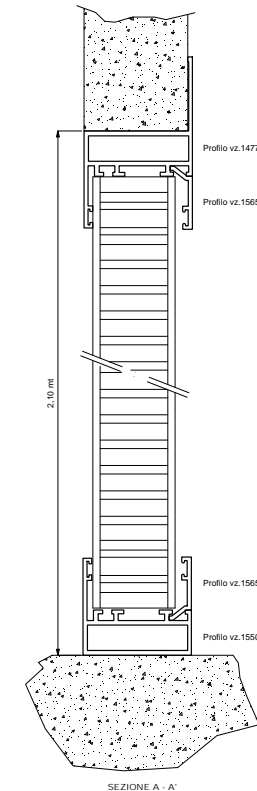

H = 2100	1 MODULO / MODULE	2 MODULI / MODULES	3 MODULI / MODULES
PANNELLO BENCORE BENCORE PANEL	1000 x 2060	1000 x 2060	1000 x 2060
ALLOGGIAMENTO NEL MURO WALL HOUSING	1040 x 2100	2047 x 2100	3047 x 2100
CODICI PROFILI PROFILE CODES	VZ 1477 telaio / frame VZ 1565 / 1552 / 1553 ferma vetro / glass stopper		
ACCESSORI ACCESSORIES	guarnizione - maniglia - cerniere gasket - handle - hinge		
COLORI STANDARD INFISSO FRAME STANDARD COLOURS	bianco - nero - argento white - black - silver		



SISTEMA ZERO / SYSTEM ZERO

PARETE / WALL

2700 / 3000 mm

ALTEZZA COMPLETA SOFFITTO-PAVIMENTO / FULL-HEIGHT DOOR

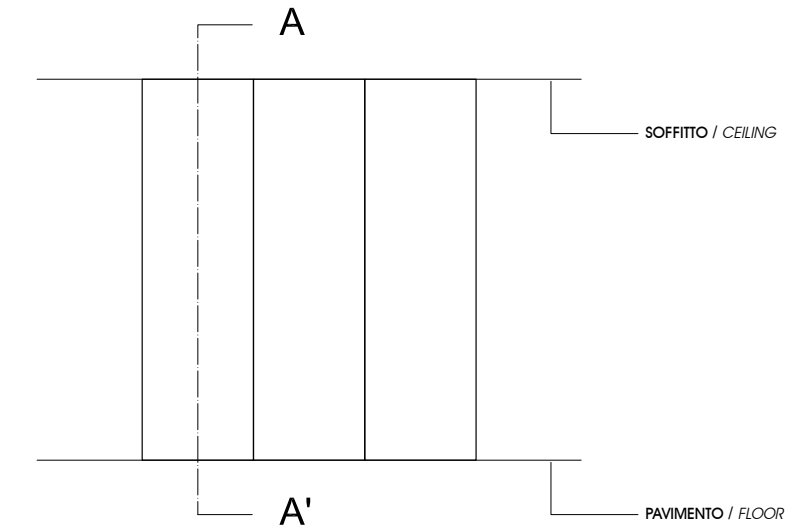
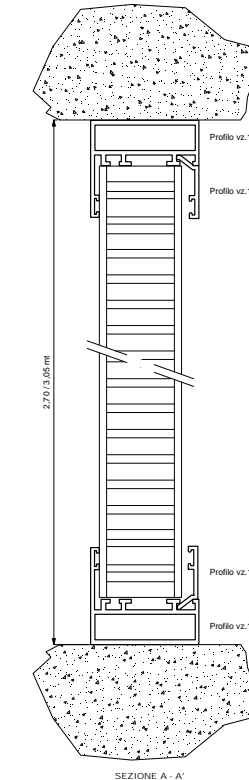

H = 2700	1 MODULO / MODULE	2 MODULI / MODULES	3 MODULI / MODULES
PANNELLO BENCORE BENCORE PANEL	1000 x 2660	1000 x 2660	1000 x 2660
ALLOGGIAMENTO NEL MURO WALL HOUSING	1040 x 2700	2047 x 2700	3047 x 2700
H = 3000	1 MODULO / MODULE	2 MODULI / MODULES	3 MODULI / MODULES
PANNELLO BENCORE BENCORE PANEL	1000 x 3000	1000 x 3000	1000 x 3000
ALLOGGIAMENTO NEL MURO WALL HOUSING	1040 x 3040	2047 x 3040	3047 x 3040

CODICI PROFILI PROFILE CODES	VZ 1550 telaio / frame VZ 1565 / 1562 / 1553 ferma vetro / glass stopper
ACCESSORI ACCESSORIES	guarnizione - maniglia - cerniere gasket - handle - hinge
COLORI STANDARD INFISSO FRAME STANDARD COLOURS	bianco - nero - argento white - black - silver

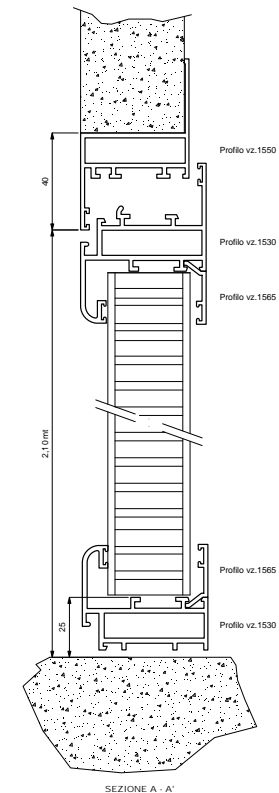

SISTEMA ZERO / SYSTEM ZERO

PORTA / DOOR

2100x800 mm

INSERIMENTO SU MURATURA ESISTENTE / HOUSING IN EXISTENT WALL

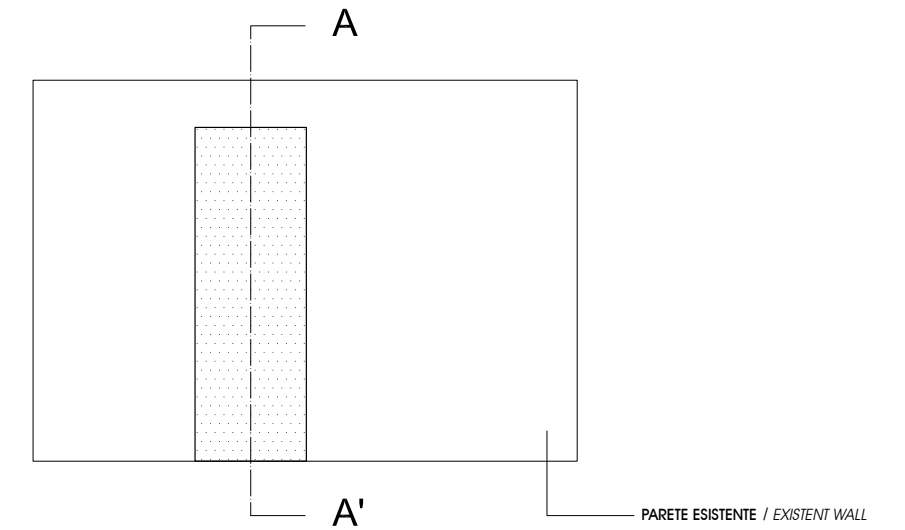

H = 2100

LUCE UTILE PASSAGGIO DOORWAY	800 x 2100	
PANNELLO BENCORE BENCORE PANEL	723 x 2055	
ALLOGGIAMENTO NEL MURO WALL HOUSING	840 x 2140	

CODICI PROFILI PROFILE CODES	VZ 1477 telaio / frame - VZ 1530 porta / door VZ 1565 / 1552 / 1553 ferma vetro / glass stopper
---------------------------------	---

ACCESSORI ACCESSORIES	guarnizione - maniglia - cerniere gasket - handle - hinge
--------------------------	--

COLORI STANDARD INFISSO FRAME STANDARD COLOURS	bianco - nero - argento white - black - silver
---	---



SISTEMA ZERO / SYSTEM ZERO

PORTA / DOOR

2700x800 / 3050x800 mm

ALTEZZA COMPLETA SOFFITTO-PAVIMENTO / FULL-HEIGHT DOOR

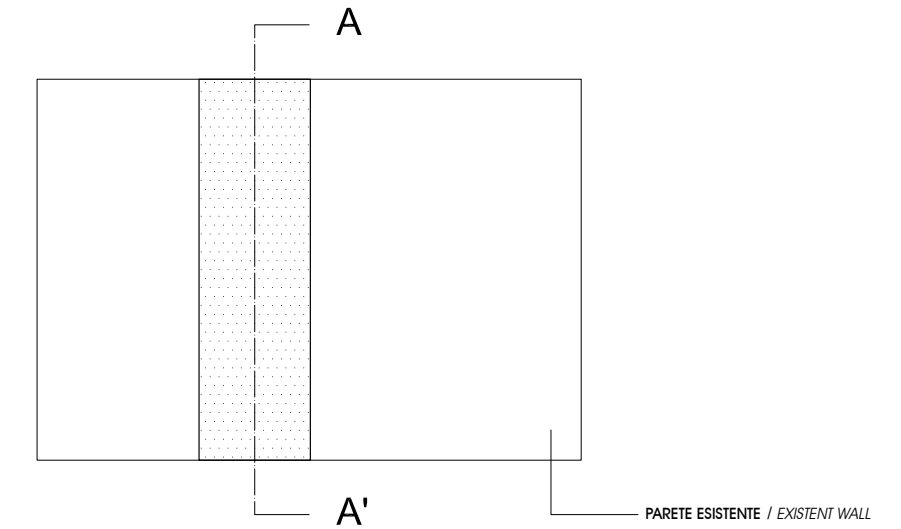
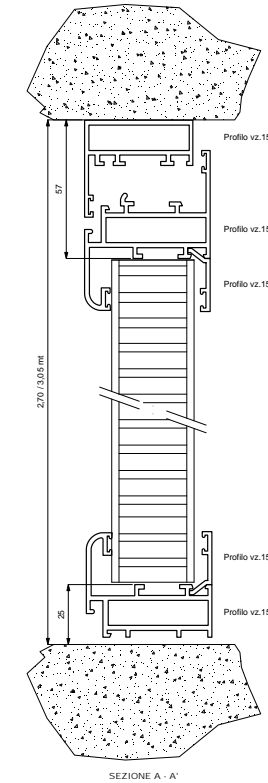

	H = 2700	H = 3000
LUCE UTILE PASSAGGIO DOORWAY	800 x 2660	1034 x 3045
PANNELLO BENCORE BENCORE PANEL	723 x 2615	1000 x 3000
ALLOGGIAMENTO NEL MURO WALL HOUSING	840 x 2700	1114 x 3085

CODICI PROFILI PROFILE CODES	VZ 1550 telaio / frame - VZ 1530 porta / door VZ 1565 / 1552 / 1553 ferma vetro / glass stopper
ACCESSORI ACCESSORIES	guarnizione - maniglia - cerniere gasket - handle - hinge
COLORI STANDARD INFISSO FRAME STANDARD COLOURS	bianco - nero - argento white - black - silver

SEQUENZA DI MONTAGGIO / INSTALLATION SEQUENCE

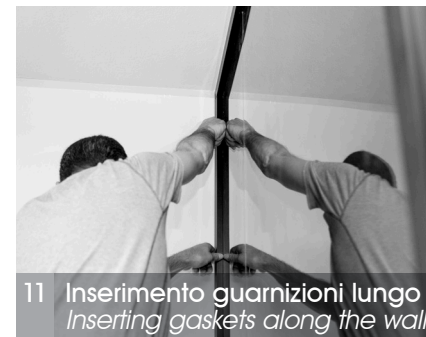
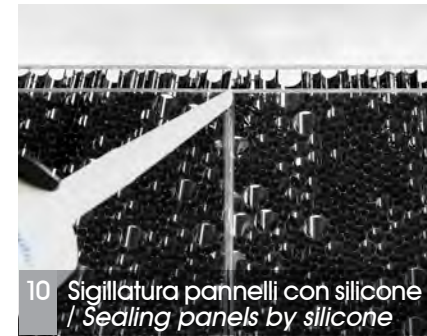
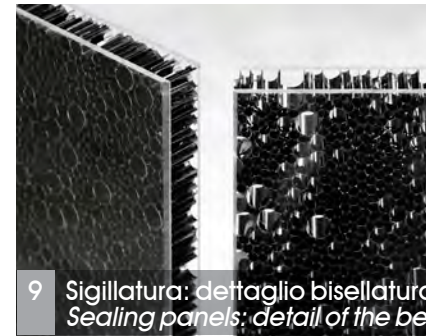
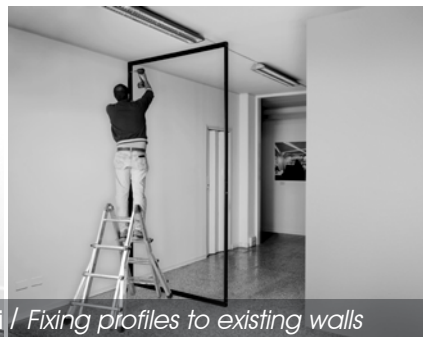

PROFILI / PROFILES

DISEGNI CAD DEI PROFILI DISPONIBILI SU RICHIESTA /
PROFILES CAD-DRAWINGS AVAILABLE ON DEMAND

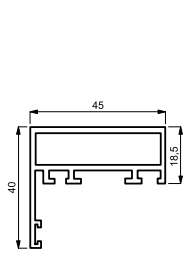
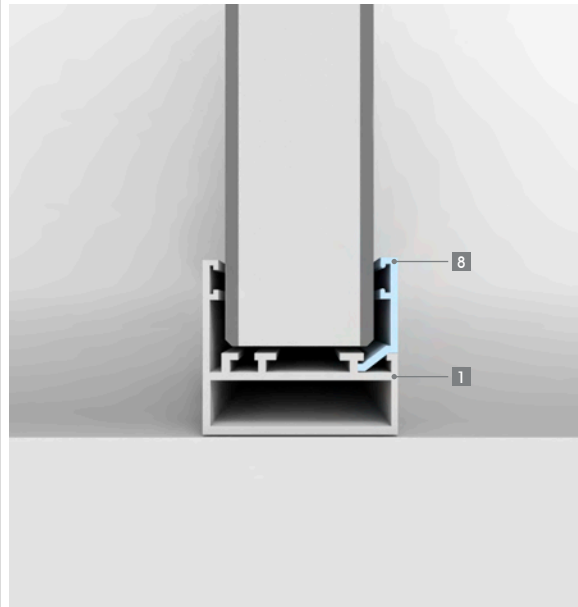
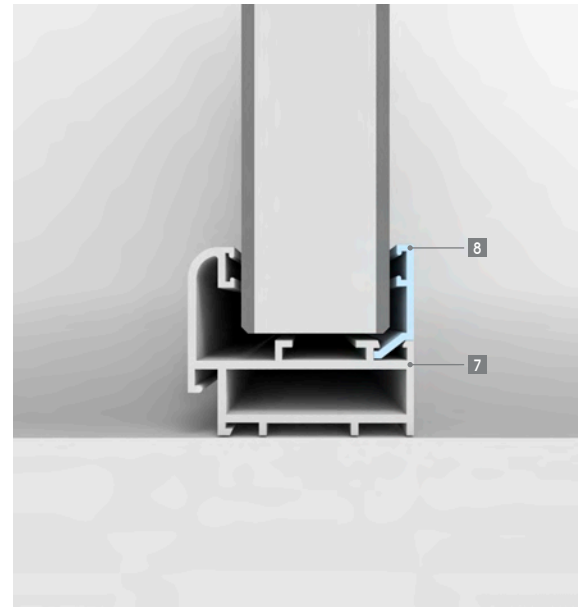
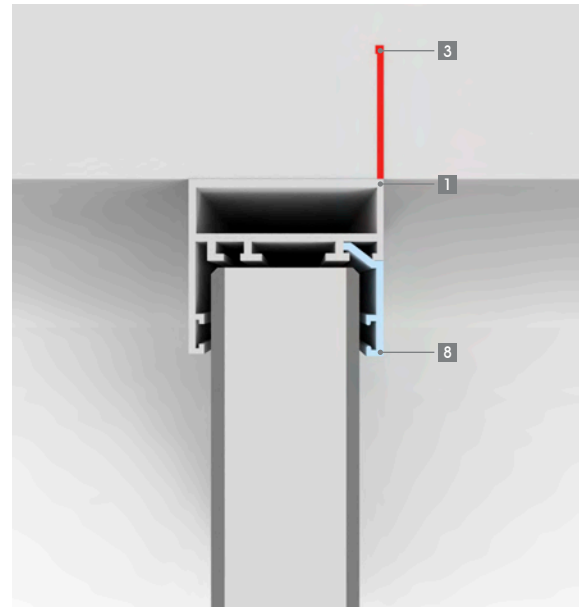
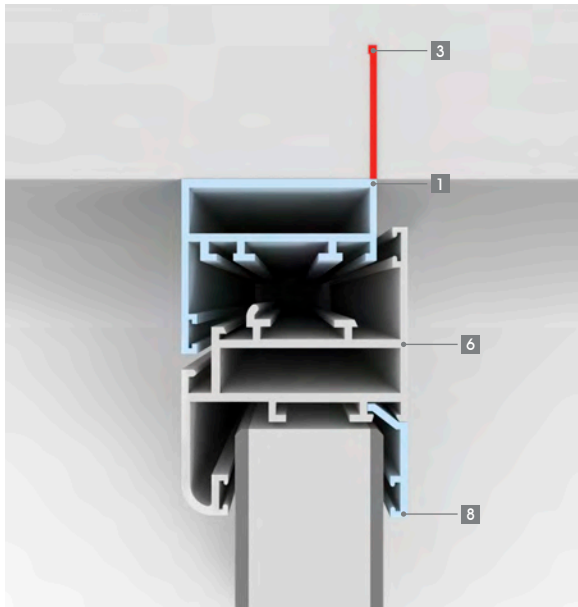

1 Profilo vz.1550

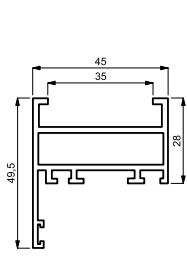

2 Profilo vz.1556

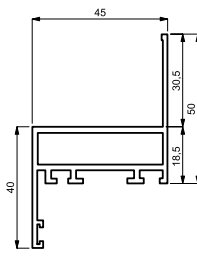

3 Profilo vz.1477

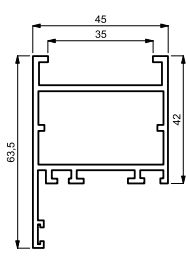

4 Profilo vz.1588

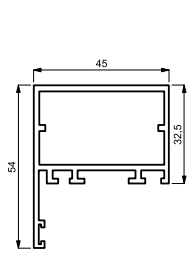

5 Profilo vz.1448

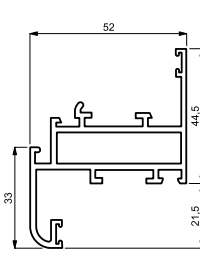

6 Profilo vz.1530

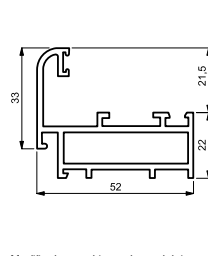

Modificata per chiusura bassa telaio porta
Modified for door frame low closing

7 Profilo vz.1530



8 Profilo vz.1565

PROFILI PERIMETRALI PARETE E PORTA
PROFILES WALL AND DOOR

PROFILI TELAIO PORTA
PROFILES DOOR

FERMA-VETRO
STOP-GLASS

GIUNZIONI / CONNECTIONS

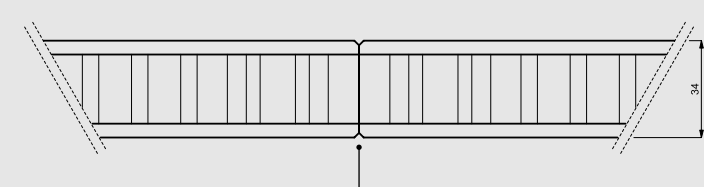
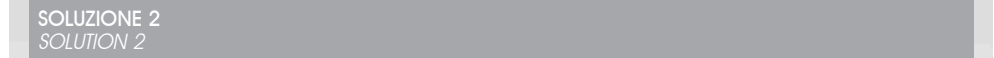
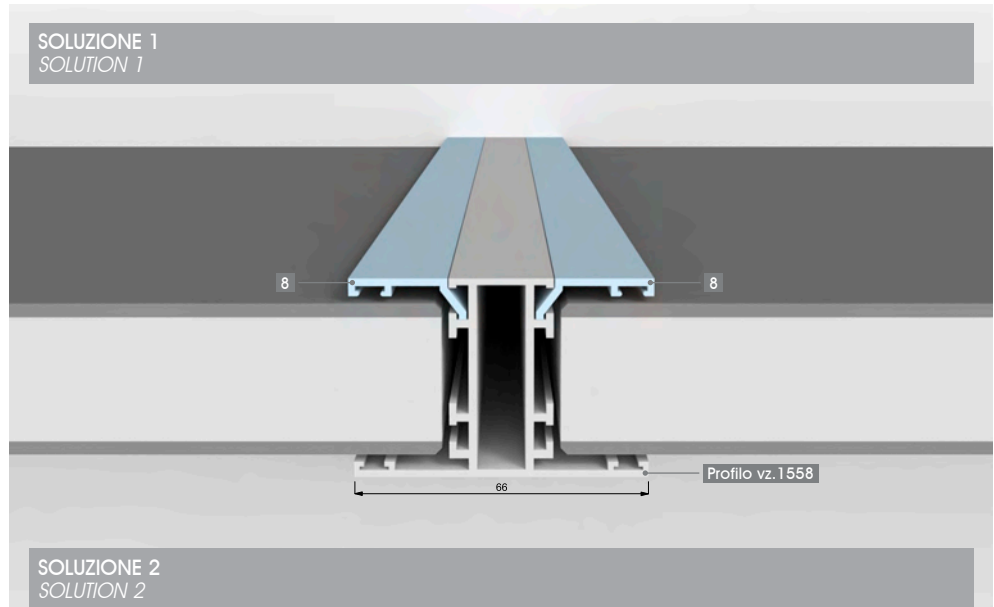

Unione tra pannelli per siliconatura su bisello
Joining panels by sealant along a V-shaped groove

SOLUZIONE 1
SOLUTION 1

SOLUZIONE 2
SOLUTION 2

STARLIGHT
34 mm

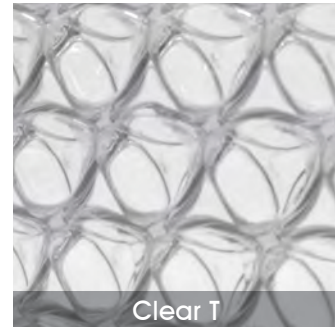

Clear T



Clear S

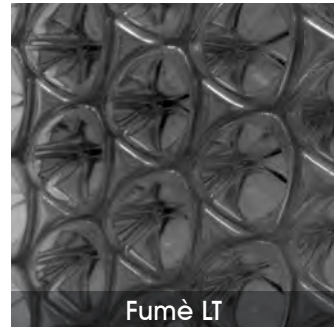

Fumè LT



Bronzo LT

LIGHTBEN
Large 34 mm

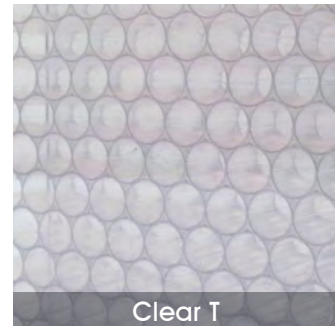

Clear T

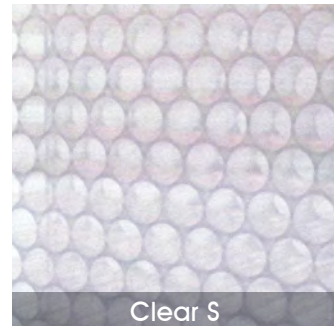

Clear S

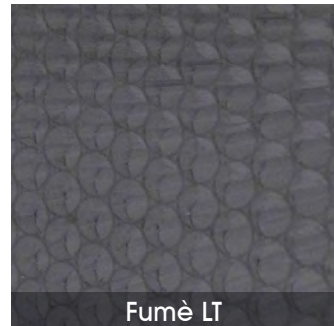

Fumè LT

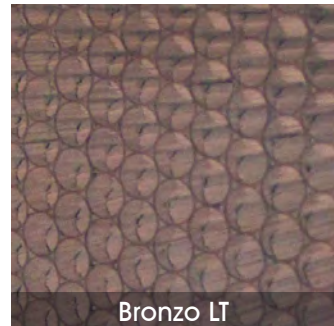

Bronzo LT

LIGHTBEN
Kaos 34 mm

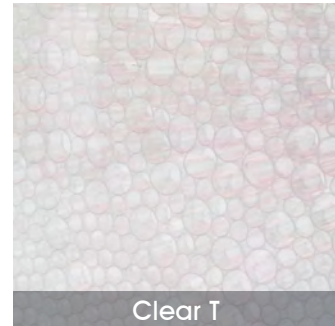

Clear T

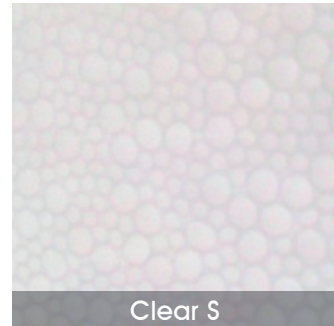

Clear S

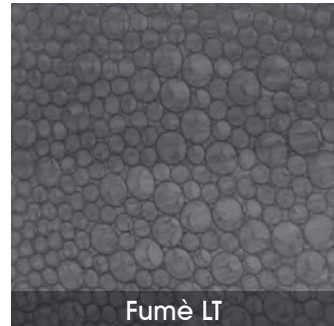

Fumè LT

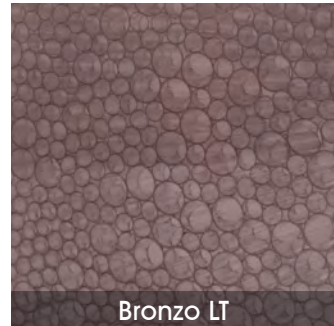

Bronzo LT

LIGHTBEN
Kaos 3D
Black 34 mm

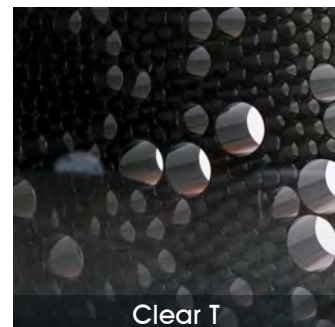

Clear T



ECOBEN
34 mm

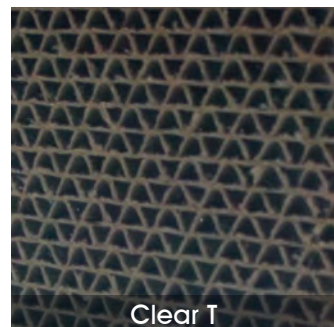

Clear T

SISTEMA ZERO / SYSTEM ZERO

GAMMA COLORI / COLOUR RANGE

Il sistema Zero impiega i pannelli delle collezioni Bencore Starlight, Lightben Large, Lightben Kaos 3D Black ed Ecoben declinati in una gamma di colori neutri quali il bronzo e il fumé chiari e il trasparente incolore con finitura lucida e satinata. La struttura in alluminio è proposta nei colori base bianco, nero e silver. Su richiesta sia i pannelli che la struttura, sono comunque disponibili in un'ampia gamma di colori aggiuntivi.

System Zero is based on panels of Bencore Starlight, Lightben Large, Lightben Kaos and Ecoben Collections available in neutral colors like Light Bronze and Fumé and translucent in Glossy and Satin finishes. The aluminum structure is available in three base colours: black, white and silver. On demand both panels and structure are available in a wide additional colour range.

PROFILI
PROFILES



Black



White



Silver

ALTRI SISTEMI / *OTHER SYSTEMS*

Con i sistemi One, Two e Three Bencore propone una serie di soluzioni per porte ad anta battente e soccorrevoli per rispondere a molteplici esigenze estetiche e di spazio sia per l'abitazione che per gli uffici. Questi sistemi sono pensati per essere abbinati ai pannelli della gamma Bencore in vari colori e finiture.

With Systems One, Two and Three Bencore offers new solutions for sliding and swing doors to answer aesthetical and space requirements for living working spaces. These Systems are designed to match Bencore panels in various colours and finishes.



SISTEMA UNO / SYSTEM ONE

PORTA BATTENTE CON PROFILO MANIGLIA /
DOOR WITH HANDLE FRAME

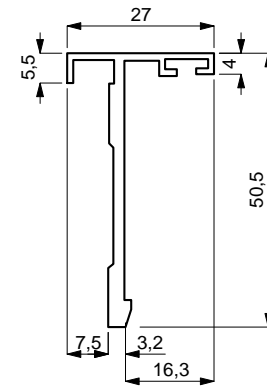

Profilo Mod. 1750

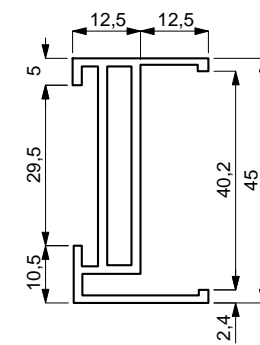

Profilo Mod. 1755





SISTEMA DUE / SYSTEM TWO

PORTA SCORREVOLE CON SISTEMA A CARRUCOLA /
SLIDING DOOR WITH PULLEY SYSTEM

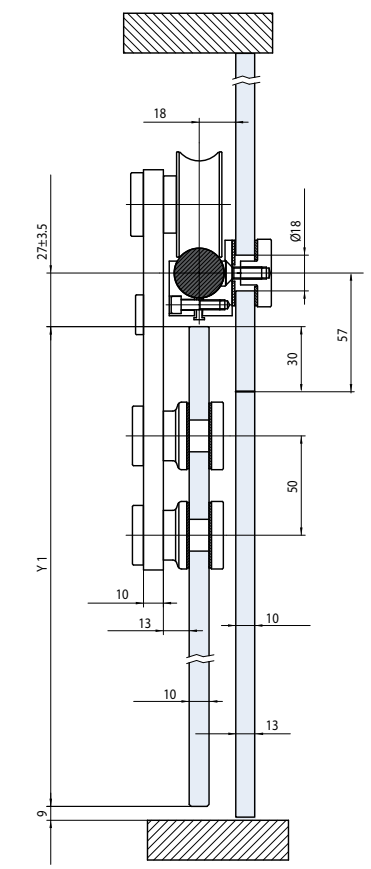

$$Y1 = H (\text{passaggio}) + 30 - 9$$





SISTEMA TRE / SYSTEM THREE

PORTA SCORREVOLE CON SISTEMA A BINARIO /
SLIDING DOOR WITH RAIL SYSTEM

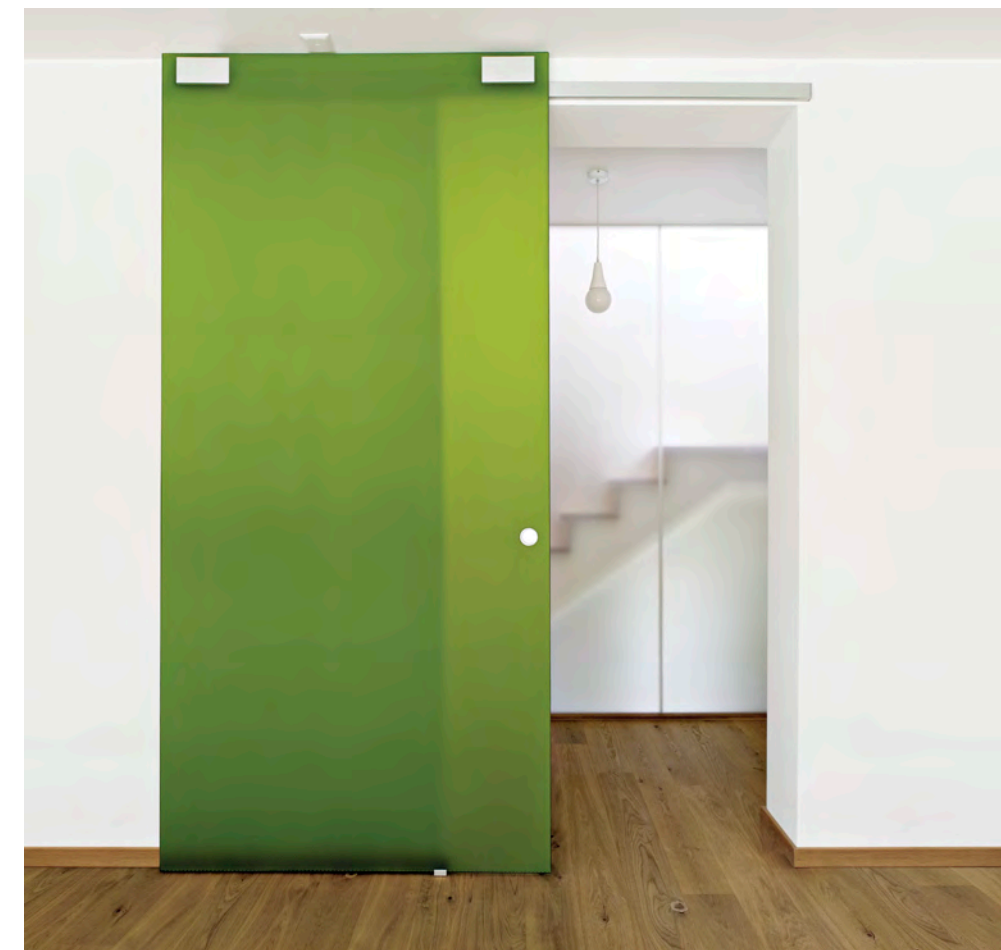
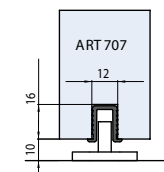
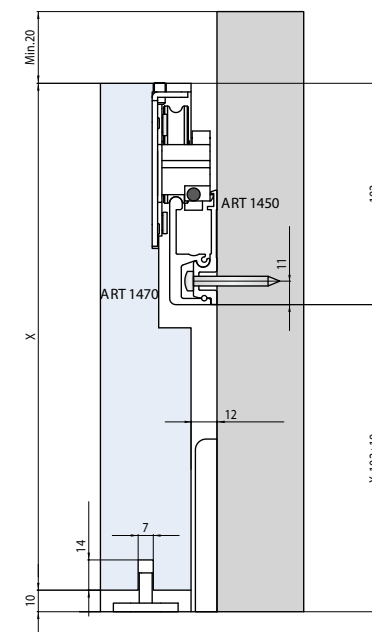



Office: Via Provinciale Nazzano, 20 – 54033 Carrara – ITALY
Production: Via S. Colombano, 9 – 54100 Massa – ITALY
Tel : +39 0585 830129 - Fax : +39 0585 835167
www.bencore.it – info@bencore.it – follow us on  bencore S.r.l.
P.IVA 00721540458