

CLEAR BROCHURE & POSTER HOLDERS



- 3mm Clear Acrylic
- 10pcs per carton per size

Single DL portrait
pocket 40mm deep

Double DL portrait
2 x pocket 40mm deep

Triple DL portrait
3 x pocket 40mm deep

DL Brochure Holders (holds 100 x 210mm leaflet size)

single: 08K02|EA001 double: 08K02|EA004 triple: 08K02|EA007



- 3mm Clear Acrylic
- 10pcs per carton per size

Single A5 portrait
pocket 40mm deep

Double A5 portrait
2 x pocket 40mm deep

Triple A5 portrait
3 x pocket 40mm deep

A5P Brochure Holders (holds 148 x 210mm leaflet size)

single: 08K02|EA002 double: 08K02|EA005 triple: 08K02|EA008



- 3mm Clear Acrylic
- 10pcs per carton per size

Single A4 Portrait
pocket 40mm deep

Double A4 Portrait
2 x pocket 40mm deep

Triple A4 Portrait
3 x pocket 40mm deep

A4P Brochure Holders (holds 297 x 210mm leaflet size)

single: 08K02|EA003 double: 08K02|EA006 triple: 08K02|EA009

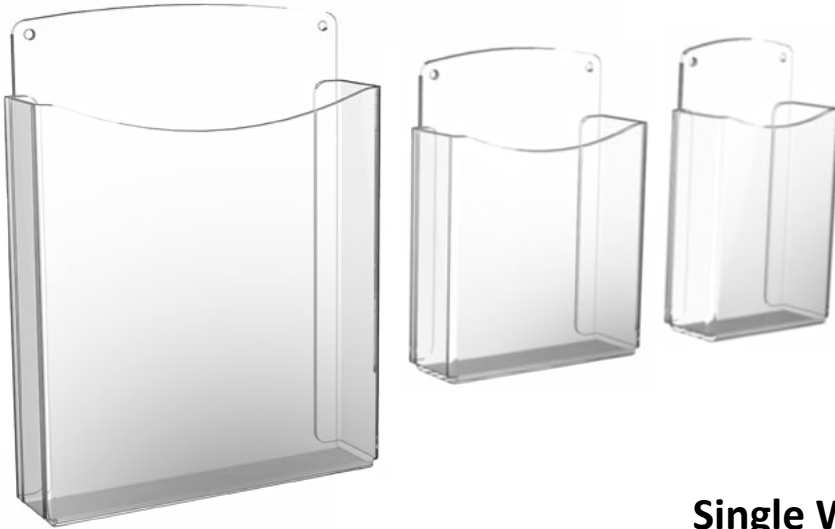

- 3mm Clear Acrylic
- 10pcs per carton per size
- pocket 40mm deep

A4 portrait - holds 210 x 297mm leaflet

A5 portrait - holds 148 x 210mm leaflet

DL portrait - holds 100 x 210mm leaflet

* specify tape or mounting screw application on order. Mounting screws not included.

Single Wall Mounted Brochure Holder

A4: 07K02|EA012

A5: 07K02|EA011

DL: 07K02|EA010



- 3mm Clear Acrylic
- 10pcs/carton
- pocket 40mm deep
- holds A4 poster insert & DL brochures

A4 Poster & DL Brochure Combo

07K02|EA013

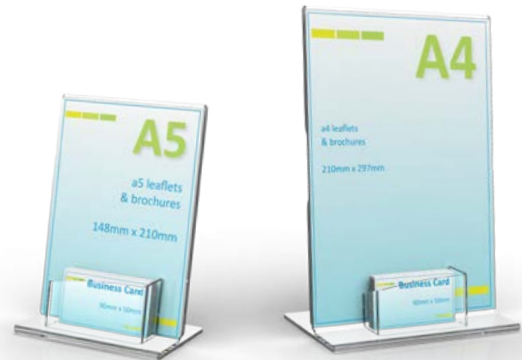

- 3mm Clear Acrylic
- 10pcs per carton per size
- pocket 30mm deep
- holds A4 insert & business cards
- holds A5 insert & business cards

Poster & Business Card Combo

A5: 07K02|EA015

A4: 07K02|EA014

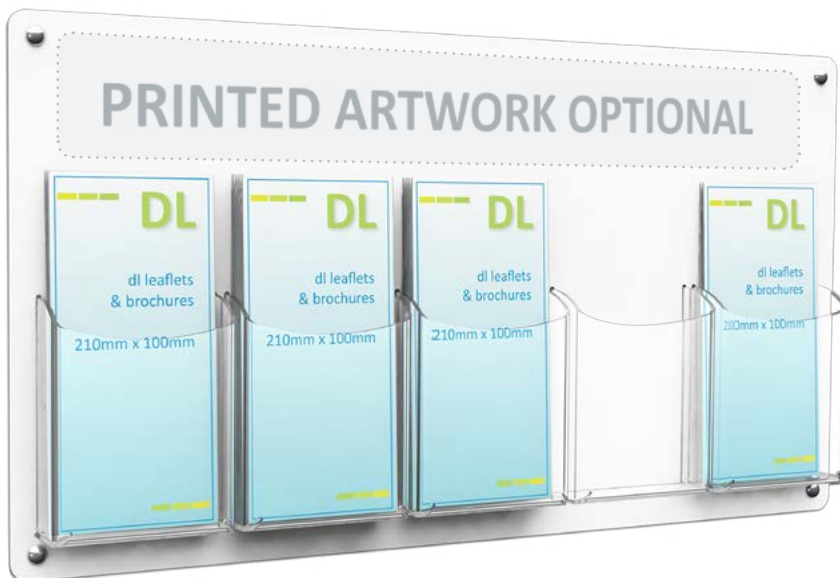

- White Acrylic Backing
- 3mm Clear Acrylic pockets
- 5 x 40mm deep pockets
- 2pcs/carton
- holds 100 x 210 DL brochures

* mounting screws & dome nuts included
* printed artwork or branding optional subject to minimum quantities and artwork changes

5 DL Pocket Multi Wall Mount

08K02|EA016



- 3mm Clear Acrylic
- 10pcs per carton per size
- A4 & A3 portrait
- * specify size on order

Monster T-Stands (A4 & A3)
08K02 | EA021



- 10mm Clear Acrylic Base
- 5mm Clear Acrylic Upright
- 10pcs per carton per size

* specify size on order

Landscape Chunky T-Stand
08K02 | EA020



- 10mm Clear Acrylic Base
- 5mm Clear Acrylic Upright
- 10pcs per carton
- insert size: 200 x 600mm

Chunky Spine Sign
08K02 | EA022

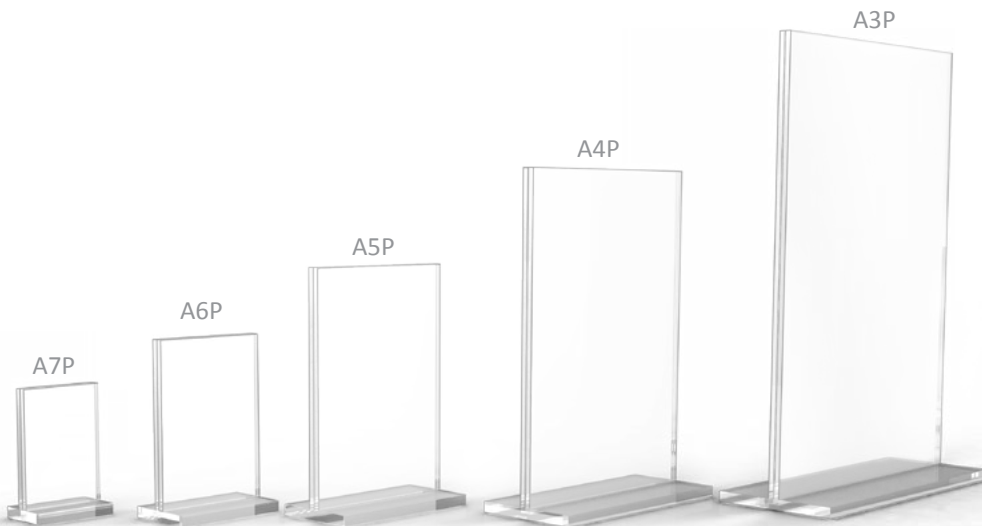

- 10mm clear acrylic base
- 5mm clear acrylic upright
- 10pcs per carton per size

A3 portrait - holds 420 x 297mm insert

A4 portrait - holds 210 x 297mm insert

A5 portrait - holds 148 x 210mm insert

A6 portrait - holds 105 x 148mm insert

A7 portrait - holds 95 x 70mm insert

* specify size on order

Portrait Chunky T-Stand
08K02 | EA019

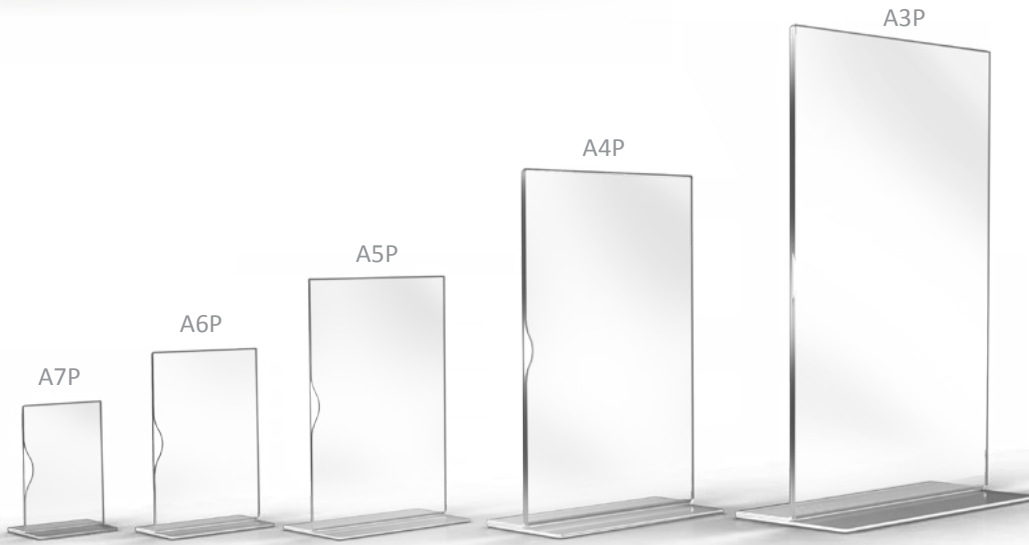

- Clear Acrylic or PETG options
- Specify material thickness: 1.5mm / 2mm / 3mm
- 10pcs per carton per size
- A3 portrait - holds 420 x 297mm insert
- A4 portrait - holds 210 x 297mm insert
- A5 portrait - holds 148 x 210mm insert
- A6 portrait - holds 105 x 148mm insert
- A7 portrait - holds 95 x 70mm insert
- * specify size on order

Portrait T-Stands
08K02|EA017

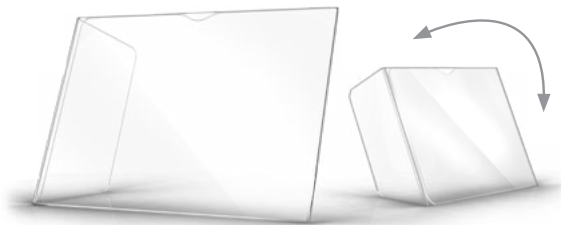

**turn on its side for landscape option*

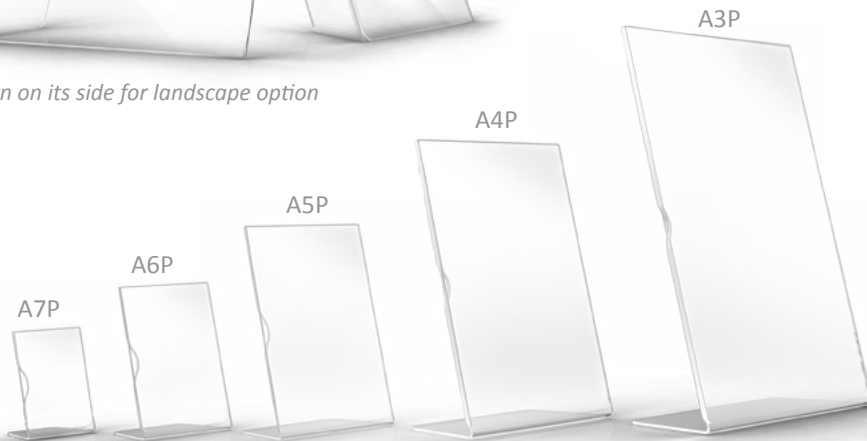

- Clear Acrylic or PETG options
- Specify material thickness: 1.5mm / 2mm / 3mm
- 10pcs per carton per size
- A3 portrait - holds 420 x 297mm insert
- A4 portrait - holds 210 x 297mm insert
- A5 portrait - holds 148 x 210mm insert
- A6 portrait - holds 105 x 148mm insert
- A7 portrait - holds 95 x 70mm insert
- * specify size on order

Portrait/Landscape L-Stands
08K02|EA018

- 10pcs per carton per size
- 15mm clear base
- arm holds A4P or A5L sleeve

* Specify on order which size sleeve is required

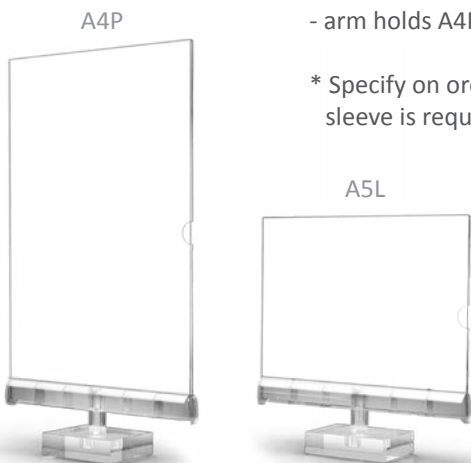

A4 Vendor Base, Arm & Sleeve
LHK02|A4VEND

- 10pcs per carton per size
- 15mm clear base
- arms available in grey & clear
- arm holds A5P or A6L sleeve

* Specify on order which size sleeve is required & colour of arm

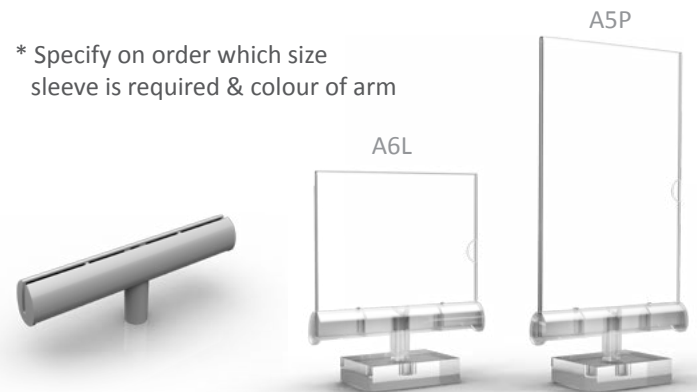

A5 Vendor Base, Arm & Sleeve
LHK02|A5VEND